

LAKE FLORES

**COMMUNITY DEVELOPMENT
DISTRICT**

December 12, 2023

BOARD OF SUPERVISORS

RFP EVALUATION

COMMITTEE

MEETING AGENDA

LAKE FLORES

COMMUNITY DEVELOPMENT DISTRICT

AGENDA

LETTER

Lake Flores Community Development District
OFFICE OF THE DISTRICT MANAGER
2300 Glades Road, Suite 410W•Boca Raton, Florida 33431
Phone: (561) 571-0010•Toll-free: (877) 276-0889•Fax: (561) 571-0013

December 5, 2023

Board of Supervisors
Lake Flores Community Development District

Dear Board Members:

The Board of Supervisors of the Lake Flores Community Development District will hold an RFP Evaluation Committee Meeting on December 12, 2023 at 1:00 p.m., at 8116 Cortez Road W., Bradenton, Florida 34210. The agenda is as follows:

1. Call to Order/Roll Call

NOTE: NO OFFICIAL ACTION OF THE BOARD WILL BE TAKEN

2. Evaluation of Lake Flores, Outfall DS-3 Project Proposal Packages
 - A. Affidavit of Publication
 - B. RFP Package
 - C. Respondents
3. Adjournment

If you should have any questions or concerns, please do not hesitate to contact me directly at (561) 719-8675 or Kristen Suit at (410) 207-1802.

Sincerely,

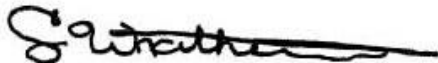

Craig Wrathell
District Manager

ATTENDEES:

Please identify yourself each time you speak to facilitate accurate transcription of meeting minutes.

FOR BOARD MEMBERS AND STAFF TO ATTEND BY TELEPHONE

CALL-IN NUMBER: 1-888-354-0094

PARTICIPANT PASSCODE: 943 865 3730

LAKE FLORES

COMMUNITY DEVELOPMENT DISTRICT

2A

Publication Date
2023-11-03

Subcategory
Miscellaneous Notices

LAKE FLORES COMMUNITY DEVELOPMENT DISTRICT REQUEST FOR PROPOSALS AND NOTICE OF SPECIAL MEETING TO OPEN PROPOSALS Manatee County, Florida

Notice is hereby given that the Lake Flores Community Development District ("District") will receive proposals for the following District project:

Lake Flores, Outfall DS-3

The contract will require contractors to provide for the construction, labor, materials, and equipment necessary to construct all work, or a portion thereof, necessary to construct the Project, and other associated scopes as more particularly described in the Project Manual and in accordance with the plans and specifications.

The Project Manual, consisting of the proposal package, contract, proposal form, plans, and other materials, will be available for public inspection and may be obtained beginning November 3, 2023 at 10 a.m. from District Manager's office, gillyardd@whhassociates.com. Plans and Project Manual may be obtained only through a download link that will be provided upon request to the District Manager's office. It is recommended that prospective proposers email orders to the District Manager's office (gillyardd@whhassociates.com).

Proposals will be evaluated in accordance with the criteria included in the Project Manual. The District reserves the right to reject any and all proposals, make modifications to the work, award the contract in whole or in part with or without cause, provide for the delivery of the project in phases, and waive minor or technical irregularities in any Proposal, as it deems appropriate, if it determines in its discretion that it is in the District's best interests to do so. Any protest of the Project Manual, including the terms and specifications, must be filed with the District within 72 hours of receiving the Project Manual, together with a protest bond in a form acceptable to the District and in the amount of \$30,000.00. In the event the protest is successful, the protest bond shall be refunded to the protestor. In the event the protest is unsuccessful, the protest bond shall be applied towards the District's costs, expenses and attorney's fees associated with hearing and defending the protest. Failure to timely file a protest will result in a waiver of proceedings under Chapter 190, Florida Statutes, and other laws.

Proposers are hereby notified that Section 287.05701, Florida Statutes, requires that the District may not request documentation of or consider a Proposer's social, political, or ideological interests when determining if the Proposer is a responsible vendor.

Firms desiring to provide construction services for the referenced project must submit one (1) original, eight (8) hard copies, and one (1) electronic copy (flash drive) of the required proposal no later than 4pm on December 5, 2023, at the offices of Lake Flores Development office 8116 Cortez Rd. West, Bradenton, FL 34210. The District's staff will conduct a special public meeting at that place and time to publicly open the proposals. No official action will be taken at the meeting. The meeting is open to the public and will be conducted in accordance with the provisions of Florida law including but not limited to Chapter 190, Florida Statutes. A copy of the agenda for the meeting may be obtained from the District Manager's office, gillyardd@whhassociates.com. The meeting may be continued in progress without additional notice to a time, date, and location stated on the record. Pursuant to provisions of the Americans with Disabilities Act, any person requiring special accommodations to participate in this meeting is asked to advise the District Office at least forty-eight (48) hours before the meeting by contacting Wrathell Hunt & Associates, LLC, the District Manager, at (561) 571-0010, or at 2300 Glades Road, Suite 410W, Boca Raton, FL 33431. If you are hearing or speech impaired, please contact the Florida Relay Service at 1 (800) 955-8770, who can aid you in contacting the District Office.

Proposals shall be in the form provided in the Project Manual and submitted in a sealed envelope pursuant to the Instructions to Proposers. The District reserves the right to return unopened to the Proposer any proposals received after the time and date stipulated above. Each proposal shall remain binding for a minimum of one hundred and twenty (120) days after the proposal opening.

The successful Proposer will be required upon award to furnish a payment and performance bond for one hundred percent (100%) of the value of the contract, with a Surety acceptable to the District, in accordance with section 255.05, Florida Statutes.

All questions regarding the Project Manual or this project shall be directed in writing only to Karen Wilson at ZNS Engineering, LC. 1023 Manatee Ave W. Suite 510, Bradenton, FL 34205 or via email to KarenW@znseng.com. No phone inquiries please. All comments received before November 22, 2023 will be responded to in writing to all prospective bidders.

LAKE FLORES COMMUNITY DEVELOPMENT DISTRICT

Request for ProposalS for _____PROJECT

PART I. GENERAL INFORMATION (C) EVALUATION CRITERIA

1. Personnel (25 Points)

(E.g., geographic locations of the firm's headquarters or permanent office in relation to the project, capabilities and experience of key personnel, including the project manager and field supervisor; present ability to manage

this project; evaluation of existing work load; proposed staffing levels, etc.)

2. Proposer's Experience (25 Points)

(E.g., past record and experience of the Proposer in similar projects; volume of work previously performed by the firm; past performance for other community development districts in other contracts; character, integrity, reputation of respondent, etc.)

3. Understanding of Scope of Work (10 Points)

Extent to which the proposal demonstrates an understanding of the District's needs for the services requested.

4. Financial Capability (10 Points)

Extent to which the proposal demonstrates the adequacy of Proposer's financial resources and stability as a business entity, necessary to complete the services required.

5. Price (30 Total Points)

Points available for price will be allocated as follows:

25 Points will be awarded to the Proposer submitting the lowest total price proposal, (i.e., the summation of the unit price extensions using quantity estimates provided, the allowances shown, plus the proposal contractor's fee) for completing the work. Value engineering concepts deemed reasonable, in the sole discretion of the district, shall also be taken into account when determining Proposer's price proposal. All other proposals will receive a percentage of the amount based upon the difference between the Proposer's bid and the low bid.

5 Points are allocated for the reasonableness of unit prices and balance of bid.

W00000000

Nov 1-3,5-6 2023

LAKE FLORES

COMMUNITY DEVELOPMENT DISTRICT

2B

**LAKE FLORES COMMUNITY DEVELOPMENT DISTRICT
REQUEST FOR PROPOSALS
AND NOTICE OF SPECIAL MEETING TO OPEN PROPOSALS**
Manatee County, Florida

Notice is hereby given that the Lake Flores Community Development District (“District”) will receive proposals for the following District project:

LAKE FLORES, OUTFALL DS-3

The contract will require contractors to provide for the construction, labor, materials, and equipment necessary to construct all work, or a portion thereof, necessary to construct the Project, and other associated scopes as more particularly described in the Project Manual and in accordance with the plans and specifications.

The Project Manual, consisting of the proposal package, contract, proposal form, plans, and other materials, will be available for public inspection and may be obtained beginning November 3, 2023 at 10 a.m. from District Manager’s office, gillyardd@whhassociates.com. Plans and Project Manual may be obtained only through a download link that will be provided upon request to the District Manager’s office. It is recommended that prospective proposers email orders to the District Manager’s office (gillyardd@whhassociates.com).

Proposals will be evaluated in accordance with the criteria included in the Project Manual. **The District reserves the right to reject any and all proposals, make modifications to the work, award the contract in whole or in part with or without cause, provide for the delivery of the project in phases, and waive minor or technical irregularities in any Proposal, as it deems appropriate, if it determines in its discretion that it is in the District’s best interests to do so.** Any protest of the Project Manual, including the terms and specifications, must be filed with the District within 72 hours of receiving the Project Manual, together with a protest bond in a form acceptable to the District and in the amount of \$30,000.00. In the event the protest is successful, the protest bond shall be refunded to the protestor. In the event the protest is unsuccessful, the protest bond shall be applied towards the District’s costs, expenses and attorney’s fees associated with hearing and defending the protest. Failure to timely file a protest will result in a waiver of proceedings under Chapter 190, Florida Statutes, and other laws.

Proposers are hereby notified that Section 287.05701, Florida Statutes, requires that the District may not request documentation of or consider a Proposer’s social, political, or ideological interests when determining if the Proposer is a responsible vendor.

Firms desiring to provide construction services for the referenced project must submit one (1) original, eight (8) hard copies, and one (1) electronic copy (flash drive) of the required proposal no later than **4pm on December 5, 2023**, at the offices of **Lake Flores Development office 8116 Cortez Rd. West, Bradenton, FL 34210**. The District’s staff will conduct a special public meeting at that place and time to publicly open the proposals. No official action will be taken at the meeting. The meeting is open to the public and will be conducted in accordance with the provisions of Florida law including but not limited to Chapter 190, Florida Statutes. A copy of the

agenda for the meeting may be obtained from the District Manager's office, gillyardd@whhassociates.com. The meeting may be continued in progress without additional notice to a time, date, and location stated on the record. Pursuant to provisions of the Americans with Disabilities Act, any person requiring special accommodations to participate in this meeting is asked to advise the District Office at least forty-eight (48) hours before the meeting by contacting Wrathell Hunt & Associates, LLC, the District Manager, at (561) 571-0010, or at 2300 Glades Road, Suite 410W, Boca Raton, FL 33431. If you are hearing or speech impaired, please contact the Florida Relay Service at 1 (800) 955-8770, who can aid you in contacting the District Office.

Proposals shall be in the form provided in the Project Manual and submitted in a sealed envelope pursuant to the Instructions to Proposers. The District reserves the right to return unopened to the Proposer any proposals received after the time and date stipulated above. Each proposal shall remain binding for a minimum of one hundred and twenty (120) days after the proposal opening.

The successful Proposer will be required upon award to furnish a payment and performance bond for one hundred percent (100%) of the value of the contract, with a Surety acceptable to the District, in accordance with section 255.05, Florida Statutes.

All questions regarding the Project Manual or this project shall be directed in writing only to Karen Wilson at ZNS Engineering, LC. 1023 Manatee Ave W. Suite 510, Bradenton, FL 34205 or via email to KarenW@znseng.com. No phone inquiries please. All comments received before November 22, 2023 will be responded to in writing to all prospective bidders.

**LAKE FLORES COMMUNITY DEVELOPMENT DISTRICT
REQUEST FOR PROPOSALS FOR _____ PROJECT
PART I. GENERAL INFORMATION – (C) EVALUATION CRITERIA**

1. *Personnel* (25 Points)
(E.g., geographic locations of the firm’s headquarters or permanent office in relation to the project, capabilities and experience of key personnel, including the project manager and field supervisor; present ability to manage this project; evaluation of existing work load; proposed staffing levels, etc.)
2. *Proposer’s Experience* (25 Points)
(E.g., past record and experience of the Proposer in similar projects; volume of work previously performed by the firm; past performance for other community development districts in other contracts; character, integrity, reputation of respondent, etc.)
3. *Understanding of Scope of Work* (10 Points)
Extent to which the proposal demonstrates an understanding of the District’s needs for the services requested.
4. *Financial Capability* (10 Points)
Extent to which the proposal demonstrates the adequacy of Proposer’s financial resources and stability as a business entity, necessary to complete the services required.
5. *Price* (30 Total Points)
Points available for price will be allocated as follows:

25 Points will be awarded to the Proposer submitting the lowest total price proposal, (i.e., the summation of the unit price extensions using quantity estimates provided, the allowances shown, plus the proposal contractor’s fee) for completing the work. Value engineering concepts deemed reasonable, in the sole discretion of the district, shall also be taken into account when determining Proposer’s price proposal. All other proposals will receive a percentage of the amount based upon the difference between the Proposer’s bid and the low bid.

5 Points are allocated for the reasonableness of unit prices and balance of bid.

ORDER DETAILS

PREVIEW FOR AD NUMBER IPL01461910

Order Number:
IPL0146191
External Order #:
485309
Order Status:
 Approved
Classification:
 Legals & Public Notices
Package:
 BRD - Legal Ads
Final Cost:
 \$1,042.47
Payment Type:
 Account Billed
User ID:
 IPL0019190

ACCOUNT INFORMATION

ZNS ENGINEERING IP
 1023 Manatee Avenue West, 7th Fl
 BRADENTON, FL 34205
 941-748-8080
 robinb@znseng.com
 ZNS ENGINEERING

TRANSACTION REPORT

Date
 October 31, 2023 7:42:55 AM EDT
Amount:
 \$1,042.47

SCHEDULE FOR AD NUMBER IPL01461910

November 1, 2023
 Bradenton Herald Print
 November 2, 2023
 Bradenton Herald Print
 November 3, 2023
 Bradenton Herald Print

LAKE FLORES COMMUNITY DEVELOPMENT DISTRICT REQUEST FOR PROPOSALS AND NOTICE OF SPECIAL MEETING TO OPEN PROPOSALS Manatee County, Florida

Notice is hereby given that the Lake Flores Community Development District ("District") will receive proposals for the following District project:

Lake Flores, Outfall DS-3

The contract will require contractors to provide for the construction, labor, materials, and equipment necessary to construct all work, or a portion thereof, necessary to construct the Project, and other associated scopes as more particularly described in the Project Manual and in accordance with the plans and specifications.

The Project Manual, consisting of the proposal package, contract, proposal form, plans, and other materials, will be available for public inspection and may be obtained beginning November 3, 2023 at 10 a.m. from District Manager's office, gilyardd@whassociates.com. Plans and Project Manual may be obtained only through a download link that will be provided upon request to the District Manager's office. It is recommended that prospective proposers email orders to the District Manager's office (gilyardd@whassociates.com).

Proposals will be evaluated in accordance with the criteria included in the Project Manual. **The District reserves the right to reject any and all proposals, make modifications to the work, award the contract in whole or in part with or without cause, provide for the delivery of the project in phases, and waive minor or technical irregularities in any Proposal, as it deems appropriate, if it determines in its discretion that it is in the District's best interests to do so.** Any protest of the Project Manual, including the terms and specifications, must be filed with the District within 72 hours of receiving the Project Manual, together with a protest bond in a form acceptable to the District and in the amount of \$30,000.00. In the event the protest is successful, the protest bond shall be refunded to the protestor. In the event the protest is unsuccessful, the protest bond shall be applied towards the District's costs, expenses and attorney's fees associated with hearing and defending the protest. Failure to timely file a protest will result in a waiver of proceedings under Chapter 190, Florida Statutes, and other laws.

Proposers are hereby notified that Section 287.05701, Florida Statutes, requires that the District may not request documentation of or consider a Proposer's social, political, or ideological interests when determining if the Proposer is a responsible vendor.

Firms desiring to provide construction services for the referenced project must submit one (1) original, eight (8) hard copies, and one (1) electronic copy (flash drive) of the required proposal no later than **4pm on December 5, 2023**, at the offices of **Lake Flores Development office 8116 Cortez Rd. West, Bradenton, FL 34210**. The District's staff will conduct a special public meeting at that place and time to publicly open the proposals. No official action will be taken at the meeting. The meeting is open to the public and will be conducted in accordance with the provisions of Florida law including but not limited to Chapter 190, Florida Statutes. A copy of the agenda for the meeting may be obtained from the District Manager's office, gilyardd@whassociates.com. The meeting may be continued in progress without additional notice to a time, date, and location stated on the record. Pursuant to provisions of the Americans with Disabilities Act, any person requiring special accommodations to participate in this meeting is asked to advise the District Office at least forty-eight (48) hours before the meeting by contacting Wraithell Hunt & Associates, LLC, the District Manager, at (561) 571-0010, or at 2300 Glades Road, Suite 410W, Boca Raton, FL 33431. If you are hearing or speech impaired, please contact the Florida Relay Service at 1 (800) 955-8770, who can aid you in contacting the District Office.

Proposals shall be in the form provided in the Project Manual and submitted in a sealed envelope pursuant to the Instructions to Proposers. The District reserves the right to return unopened to the Proposer any proposals received after the time and date stipulated above. Each proposal shall remain binding for a minimum of one hundred and twenty (120) days after the proposal opening.

The successful Proposer will be required upon award to furnish a payment and performance bond for one hundred percent (100%) of the value of the contract, with a Surety acceptable to the District, in accordance with section 255.05, Florida Statutes.

All questions regarding the Project Manual or this project shall be directed in writing only to Karen Wilson at ZNS Engineering, L.C. 1023 Manatee Ave W, Suite 510, Bradenton, FL 34205 or via email to KarenW@znseng.com. No phone inquiries please. All comments received before November 22, 2023 will be responded to in writing to all prospective bidders.

**LAKE FLORES COMMUNITY DEVELOPMENT DISTRICT
 Request for ProposalS for PROJECT
 PART I. GENERAL INFORMATION – (C) EVALUATION CRITERIA**

1. *Personnel* (25 Points)
 (E.g., geographic locations of the firm's headquarters or permanent office in relation to the project, capabilities and experience of key personnel, including the project manager and field supervisor; present ability to manage this project; evaluation of existing work load; proposed staffing levels, etc.)
2. *Proposer's Experience* (25 Points)
 (E.g., past record and experience of the Proposer in similar projects; volume of work previously performed by the firm; past performance for other community development districts in other contracts; character, integrity, reputation of respondent, etc.)
3. *Understanding of Scope of Work* (10 Points)
 Extent to which the proposal demonstrates an understanding of the District's needs for the services requested.
4. *Financial Capability* (10 Points)
 Extent to which the proposal demonstrates the adequacy of Proposer's financial resources and stability as a business entity, necessary to complete the services required.
5. *Price* (30 Total Points)
 Points available for price will be allocated as follows:
 25 Points will be awarded to the Proposer submitting the lowest total price proposal, (i.e., the summation of the unit price extensions using quantity estimates provided, the allowances shown, plus the proposal contractor's fee) for completing the work. Value engineering concepts deemed reasonable, in the sole discretion of the district, shall also be taken into account when determining Proposer's price proposal. All other proposals will receive a percentage of the amount based upon the difference between the Proposer's bid and the low bid.
 5 Points are allocated for the reasonableness of unit prices and balance of bid.

W00000000
 Nov 1-3,5-6 2023

**SECTION 01 10 00
SUMMARY OF WORK**

LAKE FLORES DS-3 STRIP

PART 1 - GENERAL

1.1 RELATED DOCUMENTS

- A. Drawings and general provisions of Contract, including Terms and Conditions, Supplemental Instructions, and all technical specification sections apply to this section.
- B. Drawing Index
 - 1) **Sheet- C001-Cover Sheet**
 - 2) **Sheet- C002- Legend & Abbreviations & Location Map**
 - 3) **Sheet-C003- Site development notes & Specifications**
 - 4) **Sheet- C005- Exiting Conditions, Demolition Plan & SW-PPP DS-3**
 - 5) **Sheet- C006 - C007 SW-PPP- Turbidity Control Plan**
 - 6) **Sheet- C009- Drainage Strip 3 & Turbidity Plan.**
 - 7) **Sheet- C010- SW-PPP- Details.**
 - 8) **Sheet- C101- Overall Site Plan**
 - 9) **Sheet- C403- Plan & Profiles**
 - 10) **Sheet- C-404- Plans & Profiles**
 - 11) **Sheet- C802 Cross sections**
 - 12) **Sheet- C900- Site details**

1.2 PROJECT DESCRIPTION

- A. Purpose of this project is to construct all work necessary to complete the DS-3 Strip.
- B. Contractor shall furnish all labor, materials, equipment, tools, transportation, and Supplies.
- C. Descriptions of each work item listed in the Bid Schedule are provided in PART 2 below.
- D. Provide materials obtained from one source for each type.
- E. Maintain a clean work environment at all times throughout the duration of the work.
- F. Provide a one-year warranty per Florida laws using the methods for the prescribed usage for installation of products and all the specs per application.
- G. All work to be in a workman manner, as set forth in the industry standards.
- H. Coordinate work schedule with the Owner Project Manager.
- I. Provide and install all slit barriers, provide temporary erosion & sediment control.
- J. Demo existing Drainage Structures, pipe & fencing.

- K. Clear and grub all vegetation with-in the property limits of the contractor scope of work.
- L. Excavation requires installing all work with-in the property Limits & permanent/temporary easements shown on the plans.
- M. Provide dewatering necessary to perform contractor work.
- N. Provide Bank grading, erosions control and sod.
- O. Supply and install all drainage pipes, structures and necessary fittings
- P. Install the Energy Dissipater with Rip Rap.
- Q. Install the Stabilized Access road.

PART 2 - DESCRIPTION OF WORK

2.1 SURVEY – Document final as-builts.

2.2 MOBILIZATION & GENERAL REQUIREMENTS

- A. Contractor shall mobilize work crews, materials, and equipment and provide on site facilities as specified in the General Requirements section.
- B. Mobilize within 10 days of the notice to proceed.
- C. Project Supervision - Contractor shall have on the project at all times that work is being performed a competent superintendent capable of reading and understanding the contract documents and experienced in the type of work being performed.
 - 1) Superintendent will receive instructions from the Engineer and shall be authorized to act for the Contractor on the project and to execute orders or directions of the engineer without delay.
 - 2) Superintendent shall promptly supply, irrespective of the amount of work sublet, all materials, equipment, tools, labor, and incidentals to complete the Contract.

PART 3 - EXECUTION

3.1 RESPONSIBILITIES

- A. Contractor Responsibilities:
 - 1) Permits and Fees - Contractor shall procure all permits and licenses, pay all charges, fees and taxes, and give all notices necessary and incidental to the due and lawful prosecution of the Contract. Prior to beginning work the Contractor shall furnish the Owner a written list of all permits required for the proper completion of the Contract. The list shall clearly identify the type of permit or permits that must be obtained before work on any particular phase or phases of work can be started. Copies of the fully executed permits shall be furnished to the County upon request.
 - 2) Construction Over and adjacent to Navigable Waters - Work on navigable waters shall be conducted to avoid interference with free navigation of the waterways and so the existing navigable depths will not be impaired except as allowed by permit issued by the U.S. Coast Guard or the U.S. Army Corps of Engineers, as applicable.

- 3) Protection and Restoration of Property and Landscape - Contractor shall preserve all private and public property and protect it from damage.
 - a. Land monuments and property marks shall not be disturbed or moved until their location has been witnessed or properly referenced and their removal approved.
 - b. Contractor shall restore damaged or injured property, at Contractor's expense, to a condition similar or equal to that existing before the damage or injury occurred, by repairing, rebuilding, or restoring the property.
 - c. Existing trees, shrubs, bushes, grass located outside the work areas but inside project limits that are damaged due to the Contractor's operations shall be replaced in kind at the Contractor's expense.
 - d. Density tests.
 - 4) Coordination - Contractor shall coordinate with each agency engaged to perform inspections, tests and similar services the sequence of activities to accommodate required services with a minimum delay.
 - a. Contractor is responsible for scheduling times for inspections, tests, taking samples and similar activities.
 - b. Contractor shall coordinate activities to avoid the necessity of removing and replacing of any new construction to accommodate inspections and tests as required by each inspection/testing agency.
- B. Owner Responsibilities:
- 1) Easements - Owner shall procure temporary construction easements for any work to be performed on private property.
 - 2) Mangrove Vegetation Line- Owner shall verify the location of the mangrove vegetation line at the downstream end of the dissipater prior to contractor initiating work.

3.2 SUBMITTALS

- A. Contractor shall provide a construction schedule and materials/methodology narrative for review and approval prior to commencement of work.
- B. Contractor shall provide shop drawings/material lists for review and approval by Engineer.

3.3 MEASUREMENT AND PAYMENT

- A. Quantities are not provided in the Bid Schedule.
- B. Contractor shall submit quantities of work completed each month along with corresponding payment application for review and approval by Engineer.

3.4 Exclusion

- A. Notice of Commencement.

END OF SECTION

Construction Plans

Issued for: Permit

Date Issued: October 2019

Latest Issue: March 2020

Index

No.	Drawing Title	Latest Issue
General Sheets		
C001	Cover Sheet	01/2020
C002	Legend, Abbreviations & Location Map	01/2020
C003	Site Development Notes & Specifications	01/2020
C004	Existing Conditions, Demolition Plan & SW-PPP DS-2	01/2020
C005	Existing Conditions, Demolition Plan & SW-PPP DS-3	01/2020
C006-C007	Turbidity Control Plan Drainage Strips 2 and 3	03/2020
C008	Drainage Strips 2 and Turbidity Plan	01/2020
C009	Drainage Strips 3 and Turbidity Plan	01/2020
C010	SW-PPP Details	01/2020
C100	Overall Site Plan DS-2	01/2020
C101	Overall Site Plan DS-3	01/2020
C401 - C404	Plan & Profile C403- C404	01/2020
C801 - C802	Cross Sections	01/2020
C900	Site Details	

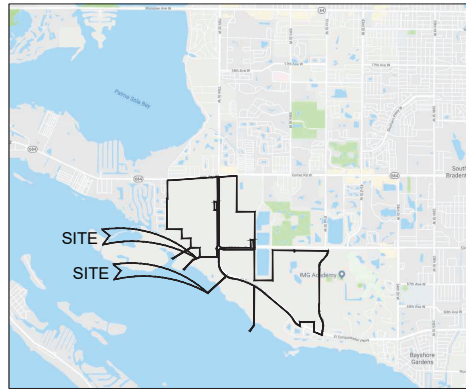

Site Vicinity Map

DRAINAGE STRIP 2 (DS-2) SECTION 7 TOWNSHIP 35S RANGE 17E
 DRAINAGE STRIP 3 (DS-3) SECTION 18 TOWNSHIP 35S RANGE 17E

LEGAL DESCRIPTION:

~~DRAINAGE STRIP 2 (DS-2)~~
 A PORTION OF THAT PARCEL DESCRIBED IN DEED BOOK 207, PAGE 154 OF THE PUBLIC RECORDS OF MANATEE COUNTY, FLORIDA, LYING IN SECTION 18, TOWNSHIP 35 SOUTH, RANGE 17 EAST, MANATEE COUNTY, FLORIDA, BEING DESCRIBED AS FOLLOWS:
 COMMENCE AT THE NORTHEAST CORNER OF THE NORTHWEST 1/4 OF SAID SECTION 18; THENCE S 01°04'51" W ALONG THE EAST LINE OF THE NORTHWEST 1/4 OF SAID SECTION 18, A DISTANCE OF 666.99 FEET; THENCE S 89°31'07" W A DISTANCE OF 1,248.80 FEET TO THE POINT OF BEGINNING; THENCE S 89°31'07" W A DISTANCE OF 593.95 FEET; THENCE S 43°47'45" W, A DISTANCE OF 1,248.80 FEET; THENCE N 49°12'10" W, A DISTANCE OF 666.99 FEET; THENCE N 43°47'45" E, A DISTANCE OF 596.88 FEET; THENCE N 89°31'07" W, A DISTANCE OF 524.11 FEET; THENCE S 89°31'25" E, A DISTANCE OF 82.24 FEET TO THE POINT OF BEGINNING.
 SAID LANDS HAVING AN AREA OF 1.05 ACRES MORE OR LESS.

DRAINAGE STRIP 3 (DS-3)
 A PORTION OF THAT PARCEL DESCRIBED IN DEED BOOK 207, PAGE 154 OF THE PUBLIC RECORDS OF MANATEE COUNTY, FLORIDA, LYING IN SECTION 18, TOWNSHIP 35 SOUTH, RANGE 17 EAST, MANATEE COUNTY, FLORIDA, BEING DESCRIBED AS FOLLOWS:
 COMMENCE AT THE SOUTHEAST CORNER OF SAID SECTION 18; THENCE N 89°31'41" W, ALONG THE SOUTH LINE OF SAID SECTION 18, A DISTANCE OF 3,374.15 FEET; THENCE N 00°30'15" E, A DISTANCE OF 2,072.15 FEET TO THE POINT OF BEGINNING; THENCE N 48°12'54" E, A DISTANCE OF 1,672.45 FEET TO THE SOUTHEASTERLY MOST CORNER OF A 10.00 FOOT RIGHT-OF-WAY AS DESCRIBED IN OFFICIAL RECORDS BOOK 2302, PAGE 893 OF THE PUBLIC RECORDS OF MANATEE COUNTY, FLORIDA, BEING A POINT ON THE ARC OF A CURVE TO THE LEFT WHOSE RADIUS POINT LIES N 33°31'42" E, AT A DISTANCE OF 1,310.26 FEET; THENCE ALONG THE ARC OF SAID CURVE IN A SOUTHEASTERLY DIRECTION, A DISTANCE OF 31.11 FEET THROUGH A CENTRAL ANGLE OF 91°21'38" TO THE SOUTHWESTERN MOST CORNER OF A 10.00 FOOT RIGHT-OF-WAY AS DESCRIBED IN OFFICIAL RECORDS BOOK 2309, PAGE 2099 OF THE PUBLIC RECORDS OF MANATEE COUNTY, FLORIDA; THENCE S 48°12'54" W, A DISTANCE OF 1,678.38 FEET; THENCE N 49°11'40" W, A DISTANCE OF 30.09 FEET TO THE POINT OF BEGINNING.
 SAID LANDS HAVING AN AREA OF 1.15 ACRES MORE OR LESS.

Lake Flores DS-2 & DS-3

Manatee County, FL

Owner & Applicant:
 Whiting Preston
 Lake Flores I, LLC
 1320 33rd Street West
 Palmetto, FL 34221

Parcel Identification #:
 5164500059 - (DS-2)
 6146500259 - (DS-3)

Development Team:

Civil Engineer:
Carnahan Proctor & Cross, Inc.
 604 Courtland Street, Suite 101
 Orlando, FL 32804
 (407) 960-5980

Planner:
Canin Associates
 500 Delaney Avenue
 Orlando, FL 32801
 (407) 422-4040

Environmental:
B. Hamilton & Associates, LLC
 7404 19th Avenue NW
 Bradenton, FL 34209
 (904) 792-3283

Geotechnical:
Universal Engineering Sciences, Inc.
 1778 Independence Boulevard, Ste. B-1
 Sarasota, FL 34234
 (941) 358-7410

Surveyor:
Carnahan Proctor & Cross, Inc.
 604 Courtland Street, Suite 101
 Orlando, FL 32804
 (407) 960-5980



CIVIL ENGINEERING
 GEOMATICS
 CONSTRUCTION SERVICES



PER COUNTY COMMENTS	3/11/20	DH
Drawing Number		
SHEET 39 OF 57		
C001		
13021702-C17MM		
130217.02		

ALL ELEVATIONS ARE BASED ON NAVD-88
 UNLESS SPECIFICALLY NOTED

48 HOURS BEFORE DIGGING
 CALL SUNSHINE
 TOLL FREE
 1-800-432-4770
 UNDERGROUND UTILITIES NOTIFICATION
 CENTER OF FLORIDA
 FIRST CALL OF FLORIDA
 1-800-227-3385
 FOR FLORIDA POWER AND LIGHT CO.

CPC Project No. 13021702
 604 Courtland Street, Suite #101
 Orlando, FL 32804
 Issued for: Permit

GENERAL NOTES

- 1. THE OWNER/DEVELOPER FOR THIS PROJECT IS LAKE FLORES L.L.C. CARNAHAN PROCTOR CROSS, INC. IS THE OWNER'S REPRESENTATIVE AND HEREAFTER REFERRED TO AS "THE ENGINEER"
2. ELEVATIONS SHOWN HEREIN ARE BASED ON THE NORTH AMERICA VERTICAL DATUM OF 1988: VERTICAL CONTROL ATTACHED NOS MONUMENT TO 14 "PUBLISHED ELEVATION"
3. ALL LABOR, MATERIALS, AND METHODS OF CONSTRUCTION SHALL BE IN STRICT ACCORDANCE WITH THE MINIMUM ENGINEERING AND CONSTRUCTION STANDARDS ADOPTED BY MANATEE COUNTY, FOOT STANDARDS, THE PLANS, AND CONSTRUCTION SPECIFICATIONS...
4. SHOP DRAWINGS OF ALL MATERIALS BEING USED SHALL BE SUBMITTED TO THE ENGINEER FOR APPROVAL PRIOR TO ORDERING MATERIALS...
5. IT WILL BE THE RESPONSIBILITY OF THE CONTRACTOR TO ENSURE THAT ALL REQUIRED PERMITS ARE OBTAINED AND IN HAND BEFORE BEGINNING ANY CONSTRUCTION...
6. THE LOCATION OF ALL EXISTING UTILITIES AND STORM DRAINAGE SHOWN ON THE PLANS HAVE BEEN DETERMINED FROM THE BEST INFORMATION AVAILABLE AND ARE GIVEN FOR THE CONVENIENCE OF THE CONTRACTOR...
7. A PRE-CONSTRUCTION MEETING IS TO BE HELD BETWEEN THE JURISDICTIONAL ENTITY, MANATEE COUNTY, ENGINEER OF RECORD, AND CONTRACTOR PRIOR TO COMMENCEMENT OF CONSTRUCTION...
8. CONSTRUCTION OBSERVATION WILL BE PROVIDED BY THE ENGINEER...
9. ALL CONTRACTORS, COUNTY REPRESENTATIVES, AND UTILITY COMPANIES ARE RESPONSIBLE FOR THEIR RESPECTIVE SURVEYING AND LAYOUT FROM BENCHMARKS...
10. THE CONTRACTOR SHALL BE RESPONSIBLE FOR ANY CONSTRUCTION ACTIVITIES FROM TAKING PLACE OUTSIDE THE LIMITS OF CONSTRUCTION...
11. THE CONTRACTOR SHALL MAINTAIN A CURRENT SET OF CONSTRUCTION PLANS AND ALL PERMITS ON THE JOB SITE DURING ALL PHASES OF CONSTRUCTION...
12. ALL PIPE CALL OUTS ARE MEASURED CENTER LINE TO CENTER LINE FOR MANHOLES AND INLETS AND FROM THE END OF THE PIPE FOR OPENED END SECTIONS...
13. ALL DETERIORATING COSTS ASSOCIATED WITH THE INSTALLATION AND CONSTRUCTION OF ANY UNDERGROUND UTILITIES, STORMWATER PIPES AND MANHOLES AND STORMWATER MANAGEMENT SYSTEMS SHALL BE INCLUDED AS PART OF THE CONSTRUCTION BID COSTS...
14. ALL UTILITIES SHALL UNDERGO OTHERS SPECIFIED IN PLANS...
15. PLANS AND SPECIFICATIONS REQUIRE THAT COMPACTED BACKFILL BE PLACED ABOVE SIDE OF AND OVER ALL UTILITIES...
16. THE LOCATIONS OF EXISTING UNDERGROUND UTILITIES ARE SHOWN IN AN APPROXIMATE WAY ONLY AND HAVE NOT BEEN INDEPENDENTLY IDENTIFIED BY THE OWNER'S REPRESENTATIVE...
17. CONTRACTOR TO REMOVE ALL EXISTING MANHOLE SURFACE FEATURES WITHIN THE LIMITS OF WORK INCLUDING BUILDING, STRUCTURES, FURNITURES, SLABS, CURBS, FENCES, UTILITY POLES, SIGNS, ETC...
18. WHERE AN EXISTING UTILITY IS FOUND TO CONFLICT WITH THE PROPOSED WORK, THE LOCATION, ELEVATION AND SIZE OF THE UTILITY SHALL BE ACCURATELY DETERMINED WITHOUT DELAY BY THE CONTRACTOR...
19. AREAS OUTSIDE THE LIMITS OF PROPOSED WORK DISTURBED BY THE CONTRACTOR'S OPERATIONS SHALL BE RESTORED BY THE CONTRACTOR TO THEIR ORIGINAL CONDITION...
20. THE CONTRACTOR SHALL MAKE ALL ARRANGEMENTS AND SHALL BE RESPONSIBLE FOR PAYING ANY FEES FOR ANY POLE RELOCATION AND FOR THE ALTERATION OR ADJUSTMENT OF GAS ELECTRIC, TELEPHONE, FIRE ALARM AND ANY OTHER PRIVATE UTILITIES BY THE UTILITY COMPANIES...
21. UPON AWARD OF CONTRACT, CONTRACTOR SHALL MAKE ALL NECESSARY CONSTRUCTION NOTIFICATIONS AND APPLY FOR AND OBTAIN ALL NECESSARY PERMITS...
22. ALL PROPOSED GRANITE BOUNDS AND ANY EXISTING MONUMENTATION DESTROYED DURING CONSTRUCTION SHALL BE RESET BY A PROFESSIONAL SURVEYOR...
23. CONTRACTOR SHALL INSTALL ALL EROSION CONTROL MEASURES PRIOR TO EARTHWORK OPERATION AND MAINTAIN ALL EROSION CONTROL MEASURES DURING CONSTRUCTION...
24. CONTRACTOR SHALL BE SOLELY RESPONSIBLE FOR SITE SECURITY AND JOB SAFETY...
25. SYMBOLS AND LEGENDS OF PROJECT FEATURES ARE GRAPHIC REPRESENTATIONS AND ARE NOT NECESSARILY SCALED TO THEIR ACTUAL DIMENSIONS OR LOCATIONS...
26. CONTRACTOR SHALL NOT RELY SOLELY ON ELECTRONIC VERSIONS OF PLANS, SPECIFICATIONS, AND DATA FILES THAT ARE OBTAINED FROM THE DESIGNER...
27. CONTRACTOR SHALL REMOVE ALL UNDER-DRAINED SYSTEM WITHIN THE LIMIT OF WORK...
28. CONTRACTOR SHALL COORDINATE WITH THE OWNER IN ORDER TO DETERMINE THE LOCATIONS OF UNDER-DRAINED SYSTEMS...
29. CONTRACTOR SHALL ALSO INCLUDE ALL COSTS ASSOCIATED WITH REMOVING AND DISPOSING OF UNDER-DRAINED SYSTEMS IN ITS BID.

MAINTENANCE OF TRAFFIC

- 1. FOR ANY ADJUSTMENT TO TRAFFIC ALONG ADJACENT STREETS TO THE PROJECT, THE CONTRACTOR SHALL CONFORM TO THE LATEST EDITION OF THE MANUAL ON UNIFORM TRAFFIC CONTROL DEVICES FOR STREETS AND HIGHWAYS (MUTCD), THE FOOT ROADWAY AND TRAFFIC DESIGN STANDARD INDICES (SERIES 600) AND MANATEE COUNTY STANDARDS.
2. PRIOR TO COMMENCING WORK, THE CONTRACTOR SHALL FURNISH, ERECT AND MAINTAIN ALL BARRICADES, WARNING SIGNS AND MARKINGS FOR HAZARDS AND THE CONTROL OF TRAFFIC ALONG THE ADJACENT STREETS.

EARTHWORK AND SITEWORK

- 1. SOIL INVESTIGATIONS FOR THE SITE WERE PROVIDED BY DUMBLEBARGER ENGINEERING & TESTING INC. AND UNIVERSAL ENGINEERING SERVICES...
2. THE CONTRACTOR SHALL BE RESPONSIBLE FOR OBTAINING THE NECESSARY TESTING BY A REGISTERED PROFESSIONAL GEOTECHNICAL ENGINEER...
3. IT IS THE CONTRACTOR'S RESPONSIBILITY TO DETERMINE EXISTING SITE CONDITIONS OF SOIL PRIOR TO NOTICE TO PROCEED TO DETERMINE IF ANY OFF-SITE MATERIALS WILL NEED TO BE IMPORTED TO ACHIEVE THE GRADATIONS...
4. ALL EXCESS FILL FROM SITE SHALL BE STOCKPILED BY THE CONTRACTOR...
5. CLEAR AREAS INDICATED SHALL BE COMPLETELY CLEAR OF ALL TIMBER, BRUSH, STUMPS, ROOTS, GRASS, WEEDS, RUBBISH, AND ALL OTHER DEBRIS...
6. PRIOR TO BID PREPARATION, THE CONTRACTOR MUST CONFER WITH THE OWNER'S SITE CONDITIONS AND PERFORM ADDITIONAL INVESTIGATIONS...
7. THE CONTRACTOR MUST INSTALL AND MAINTAIN 500 ON EXPOSED SOLETS WITHIN 48 HOURS OF COMPLETED FINAL GRADES...
8. THE CONTRACTOR SHALL BE RESPONSIBLE FOR THE PROJECT COMPLYING WITH APPLICABLE STATE WATER QUALITY STANDARDS...
9. THE CONTRACTOR, AT HIS OWN EXPENSE, SHALL OPERATE AND MAINTAIN EROSION AND SEDIMENT CONTROL DEVICES AND STRUCTURES...
10. THE CONTRACTOR SHALL TAKE ALL NECESSARY MEASURES TO CONTROL TURBIDITY INCLUDING, BUT NOT LIMITED TO, THE INSTALLATION OF TURBIDITY BARRIERS...
11. THE CONTRACTOR SHALL TAKE ALL NECESSARY MEASURES TO CONTROL TURBIDITY INCLUDING, BUT NOT LIMITED TO, THE INSTALLATION OF TURBIDITY BARRIERS...
12. CLEANING DEBRIS SHALL BE DISPOSED OF IN A LEGAL FASHION...
13. PRIOR TO START OF CONSTRUCTION, CONTRACTOR SHALL VERIFY EXISTING GROUND ELEVATIONS ADJACENT TO DRAINAGE OUTLETS...

OTHER UTILITY INFORMATION

- 1. THE CONTRACTOR SHALL SHOW ALL UTILITIES AND OTHER IMPROVEMENTS SHOWN ON THESE PLANS AND ALL OTHER UTILITIES AND OTHER IMPROVEMENTS NOT SHOWN...
2. DUCTILE IRON PIPE SHALL BE ENCASED IN POLYETHYLENE THWENTY-FIVE (25) FEET ON EACH SIDE OF ANY PERPENDICULAR CROSSING...
3. ALL ELECTRICAL CONDUIT INSTALLED UNDER PAVEMENT TO BE ENCASED IN CONCRETE.

HEM CONSTRUCTION & BACKFILL COMPACTION

- 1. POND BERM CONSTRUCTION: CLEAR AND GRUB SITE TO REMOVE VEGETATION, DEBRIS AND HIGHLY ORGANIC TOPSOIL...
2. PROOF ROLL THE BERM LOCATION WITH A LOADED DUMP TRUCK...
3. CONSTRUCT THE BERM IN LEVEL LIFTS COMPACTED TO 95 PERCENT OF THE MOISTURE PROCTOR MAXIMUM DENSITY...
4. THE EXTERIOR BERM SURFACE MUST BE SLOPED TO THE EXTENT OF THE DISTURBED AREA AFTER CONSTRUCTION...
5. THE CONTRACTOR SHALL PERFORM COMPACTION TESTING IN ACCORDANCE WITH TESTING METHODS ACCEPTED BY FEDERAL, STATE AND LOCAL AUTHORITIES...
6. STRUCTURE BACKFILLING TO SUBGRADE ELEVATIONS, SITE FILLING AND BACKFILLING, AND FILL FOR OVER EXCAVATIONS:
a) 1 TEST PER 12-18" LIFT AT STRUCTURE AND/OR OVER-EXCAVATED AREA.

AS-BUILT SURVEY REQUIREMENTS

- 1. THE CONTRACTOR SHALL REQUIRE THE PROFESSIONAL SURVEYOR AND MAPPER TO LOCATE ALL IMPROVEMENTS FOR THE AS-BUILT SURVEY...
2. IF SURVEY CONTROL POINTS ARE DESTROYED, IT IS THE RESPONSIBILITY OF THE CONTRACTOR'S SURVEYOR AND MAPPER TO RESET THE POINTS...
3. THE CONTRACTOR'S PROFESSIONAL SURVEYOR AND MAPPER SHALL LOCATE ALL IMPROVEMENTS FOR THE PROJECT AS-BUILT USING STATE PLANE COORDINATES...
4. THE EARTHWORK/EXCAVATION CONTRACTOR MUST IMPLEMENT THIS STORMWATER POLLUTION PREVENTION PLAN (SWPPP)...
5. PRIOR TO CONSTRUCTION OF EARTHWORK, SWPPP, MANATEE COUNTY AND CARNAHAN, PROCTOR AND CROSS, INC. (ENGINEER) MUST BE ADVISED...
6. PROVIDE A 25'-FOOT MINIMUM UPLAND BUFFER AS REQUIRED BETWEEN THE JURISDICTIONALLY APPROVED WETLAND BOUNDARIES...
7. THIS SWPPP PLAN HAS BEEN PREPARED WITH FOUR (4) PROPOSED DISCHARGE POINTS WITHIN THE SITE...
8. THE PONDS PROPOSED FOR CONSTRUCTION UNDER THESE CONSTRUCTION PLANS MAY RECEIVE WATER FROM DE-WATERING OPERATIONS...
9. A TURBIDITY MONITORING PROGRAM MUST BE IMPLEMENTED AT EACH POINT OF DISCHARGE...
10. ANY EXCAVATED MATERIAL REMAINING ON SITE MUST BE STOCKPILED IN THE SPECIFIC DESIGNATIONS AS SHOWN ON THE PLANS...
11. IF DEEMED NECESSARY BY SWPMO, CONTRACTOR SHALL BE RESPONSIBLE FOR IMPLEMENTING ANY CORRECTIVE MEASURES...
12. DISTRICT AUTHORIZED STAFF, UPON PROPER IDENTIFICATION, SHALL HAVE PERMISSION TO INSPECT AND OBSERVE THE CONSTRUCTION ACTIVITIES...
13. THE ENERGY DISSIPATORS WITH THEIR RESPECTIVE OUTFALL PIPES WILL BE CONSTRUCTED DURING THE DRY SEASON...
14. THE ENERGY DISSIPATORS AND THEIR RESPECTIVE PIPES SHALL BE CONSTRUCTED STARTING AT THE MANGOVES AND WORKING TOWARD THE UPLAND EXTENT...
15. POLYACRYLAMIDE (PAM) FLOCCULATION LOSS AND FULL DEPTH DOUBLE FLOATING TURBIDITY BARRIERS SHALL BE INSTALLED AT LOCATIONS...
16. CONTRACTOR SHALL INSTALL A STAFF GAUGE UPSTREAM OF EACH LOCATION WHERE TEMPORARY DITCH BLOCKS ARE TO BE INSTALLED...
17. THE CONTRACTOR SHALL MONITOR CHANGING WEATHER CONDITIONS AND MODIFY THE WORK PLAN ACCORDINGLY...
18. THE CONSTRUCTION PLANS HAVE BEEN DIVIDED INTO THREE SEPARATE SETS AS FOLLOWS: WEST MITIGATION POLE, PONDS AS AND A4 AND DRAINAGE STRIPS DS-2 AND DS-3...

TURBIDITY MONITORING PLAN

LAKE FLORES PHASE 1A
WEST MITIGATION POLE, POND AS & A4 AND DRAINAGE STRIPS DS2 & DS3
THE CONSTRUCTION OF THIS PROJECT WILL REQUIRE IN-WATER SOIL DISTURBANCE ACTIVITIES, WHICH MUST MEET THE STATE'S WATER QUALITY INTEGRATION CRITERIA PRIOR TO DISCHARGE TO SARASOTA BAY...

SCHEDULING

- 1. ALL CONSTRUCTION ACTIVITIES THAT HAVE A POTENTIAL TO CREATE TURBIDITY, SUCH AS IN-WATER SOIL DISTURBANCE, DREDGING AND FILLING SHALL REQUIRE MONITORING VISUAL INSPECTIONS SHALL COMMENCE PRIOR TO THE START OF CONSTRUCTION ACTIVITIES...
2. NO CONSTRUCTION SHALL COMMENCE UNTIL THE CONTRACTOR SUBMITS TO THE DISTRICT AND RECEIVES DISTRICT APPROVAL...
3. MONITORING SHALL CONTINUE UNTIL THE SITE HAS BEEN STABILIZED TO THE SATISFACTION OF THE PERMITTEE'S PROFESSIONAL REPRESENTATIVE...
4. CURRENT WATER SURFACE ELEVATIONS AND TURBIDITY INSPECTIONS SHALL BE RECORDED DAILY...
5. THE LOG SHALL BE USED AS A TOOL BY THE CONTRACTOR TO MAKE ADJUSTMENTS TO THE TURBIDITY CONTROLS...
6. RECORDING

- 7. NO REPORTING IS NECESSARY, HOWEVER, THE LOG SHALL BE MADE AVAILABLE TO THE PROJECT ENGINEER, COUNTY AND SWPMO COMPLIANCE INSPECTORS UPON REQUEST.

SPECIAL CONSTRUCTION NOTE

THE CONTRACTOR / DEVELOPER SHALL DESIGN AND BUILD ANY EASEMENT CROSSING AREAS, THAT HAVE CONVEYANCE PIPE INSTALLED WITHIN SUCH A MANNER THAT THE UNDERGROUND UTILITIES ARE NOT DAMAGED...
THE CONTRACTOR SHALL BE RESPONSIBLE FOR OBTAINING ALL NECESSARY PERMITS AND MUST BE UNDERTAKEN ONLY AFTER OBTAINING ALL NECESSARY PERMITS...



604 COURTLAND STREET SUITE 101
PHONE : (407) 960-5980
ORLANDO, FLORIDA 32804
CERTIFICATE OF AUTHORIZATION # 2936

CIVIL ENGINEERING
GEOMATICS
CONSTRUCTION SERVICES
E89 3926

ALL ELEVATIONS SHOWN ON THIS SHEET ARE BASED ON NAVD83 DATUM (CONVEYANCE (NAV/D83 + 0.95FT = NGVD'25)

Table with 4 columns: No., Revision, Date, Approval. Contains revision history for the drawing.

Checked by: DH, Drawn by: SR, Checked by: DH
Date: DP, Date: DH
Scale: AS SHOWN, October 2019

Lake Flores
DS-2 & DS-3
Project No.

Site Meeting Notes
& Specifications

Drawing Title: SHEET 41 OF 57
C003
Danauld H. Hayes
State of Florida
Professional Engineer
License No. 38895
11/16/2006
Professional Seal
I hereby certify that I am a duly Licensed Professional Engineer in the State of Florida.
I have prepared and sealed and signed this drawing.
I am not providing any services to the project.
I am not providing any services to the project.
I am not providing any services to the project.



CORNELIUS FROST & COMPANY
 604 COURTLAND STREET SUITE 101
 PHONE : (407) 960-5980
 ORLANDO, FLORIDA 32804
 CERTIFICATE OF AUTHORIZATION # 2936

CIVIL ENGINEERING
 GEOMATICS
 CONSTRUCTION SERVICES
 EB# 3926

Legend

	PROPERTY LINE
	MITIGATION BANK BOUNDARY
	WETLAND JURISDICTIONAL LINE
	FLUGCS CODE LIMIT LINE / MANGROVE SWAMP LIMITS

Legend

	SILT FENCE
	SOIL TRACKING PREVENTION DEVICE
	TURBIDITY BARRIER
	POWER POLE
	BACKFILL DITCHES
	TRACT LINE

0 40' 80'
 FULL SCALE: 1"=40'
 HALF SCALE: 1"=80'
 ALL ELEVATIONS SHOWN ON THIS SHEET ARE BASED ON NAVD'83 DATUM CONVERSION (NAVD'83 + 0.99FT = NGVD'29)

No.	Revision	Date	Appr'd
Designed by	DH	Drawn by	SR
Checked by	DH	Approved by	DH
Scale	AS SHOWN	Date	October 2019

Lake Flores DS-2 & DS-3

Existing Conditions, Demolition Plan & SW-PPP DS-3

Sheet 43 OF 57
C005

Daniel L. Hayes
 Licensed Professional Engineer
 License No. 48855
 I hereby certify that I am the duly qualified and licensed Professional Engineer responsible for the design and construction of the project shown on this drawing and that I am a duly licensed Professional Engineer in the State of Florida.
 Signature: Daniel L. Hayes
 Date: 10/20/19
 Project Number: 130217.02

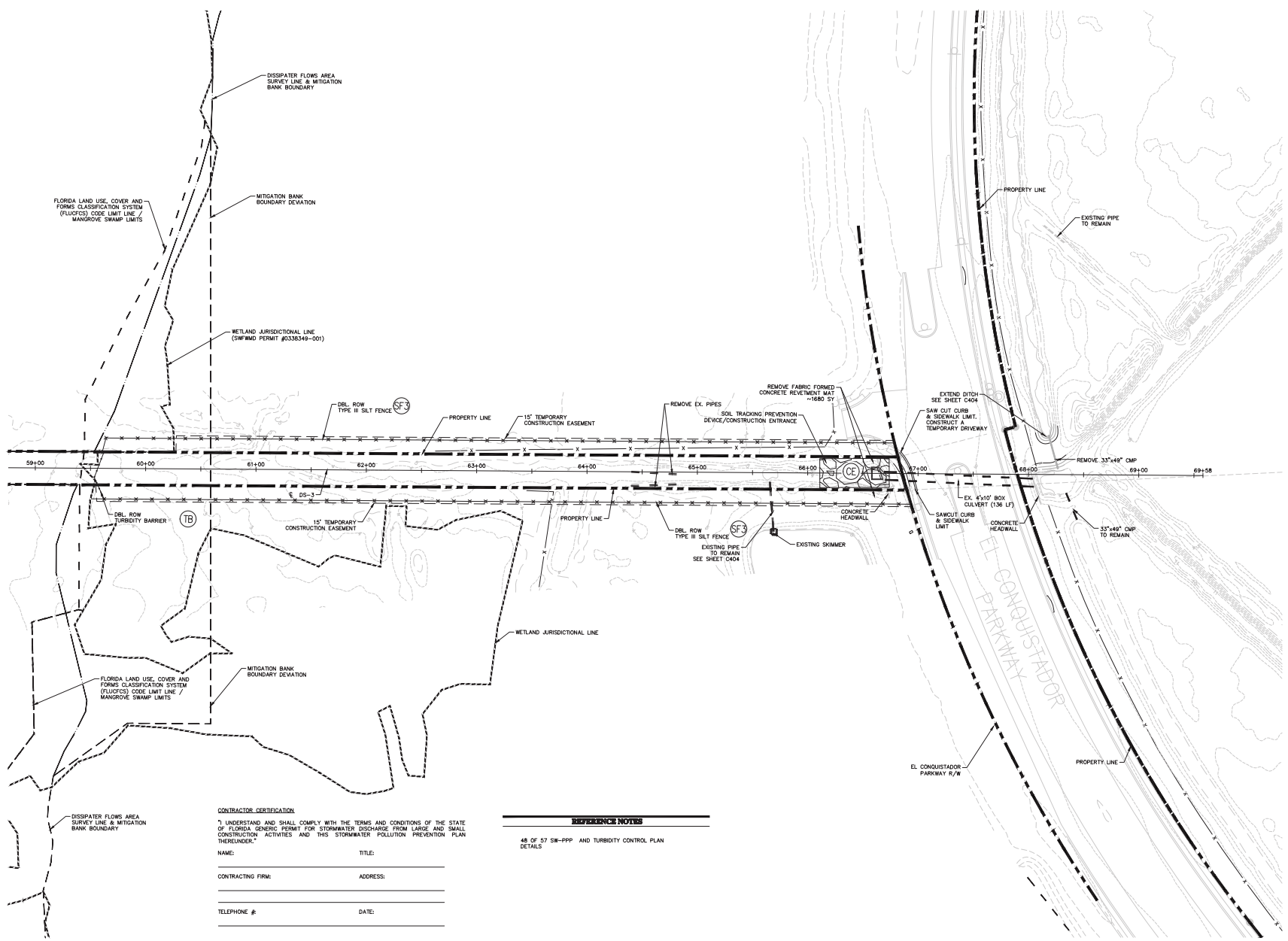

CONTRACTOR CERTIFICATION
 I, UNDERSIGNED, SHALL COMPLY WITH THE TERMS AND CONDITIONS OF THE STATE OF FLORIDA GENERIC PERMIT FOR STORMWATER DISCHARGE FROM LARGE AND SMALL CONSTRUCTION ACTIVITIES AND THIS STORMWATER POLLUTION PREVENTION PLAN THEREUNDER.
 NAME: _____ TITLE: _____
 CONTRACTING FIRM: _____ ADDRESS: _____
 TELEPHONE #: _____ DATE: _____

REFERENCE NOTES
 48 OF 57 SW-PPP AND TURBIDITY CONTROL PLAN DETAILS

P:\PROJECT FOLDERS\130217.02 - LAKE FLORES\CAD\DWG\PLAN SETS\CONSTRUCTION SETS\130217.02-005.dwg 1/20/2020 10:28 AM



CARRAHAN PROCTOR & GROSS

604 COURTLAND STREET SUITE 101
ORLANDO, FLORIDA 32804
CERTIFICATE OF AUTHORIZATION # 2936

CIVIL ENGINEERING
GEOMATICS
CONSTRUCTION SERVICES
FIR# 3926

Legend

	SI-F	SILT FENCE
	CE	SOIL TRACKING PREVENTION DEVICE
	FTB	FLOATING TURBIDITY BARRIER
	STB	STAKED TURBIDITY BARRIER
	V	VISUAL INSPECTION LOCATION
	SG	STAFF GAUGE LOCATION
	→	DITCH FLOW DIRECTION
	1.29	EXISTING SPOT ELEVATION
	- - - -	PROPERTY LINE
	- - - -	MITIGATION BANK BOUNDARY
	- - - -	WETLAND JURISDICTIONAL LINE
	- - - -	FLUOROC'S LIMIT LINE / MANGROVE SWAMP LIMITS
	XXXX	BACKFILL DITCHES

0 200' 400'
FULL SCALE: 1"=200'
HALF SCALE: 1"=400'

ALL ELEVATIONS SHOWN ON THIS SHEET ARE BASED ON NAVD'83 DATUM CONVERSION (NAVD'83 + 0.99FT = NGVD'29)

DESIGNED BY	DH	DRAWN BY	SR	CHECKED BY	DH
SCALE	AS SHOWN	DATE	October 2019	APPROVED BY	DH

PER COUNTY COMMENTS 3/11/20 DH

Lake Flores DS-2 & DS-3

Project Title

Turbidity Control Plan Drainage Strips 2 and 3

Drawing Title

SHEET 44 OF 57

C006

Daniel J. Hayes
Professional Engineer
No. 130317-02
Project Number

130317-02

Project Number

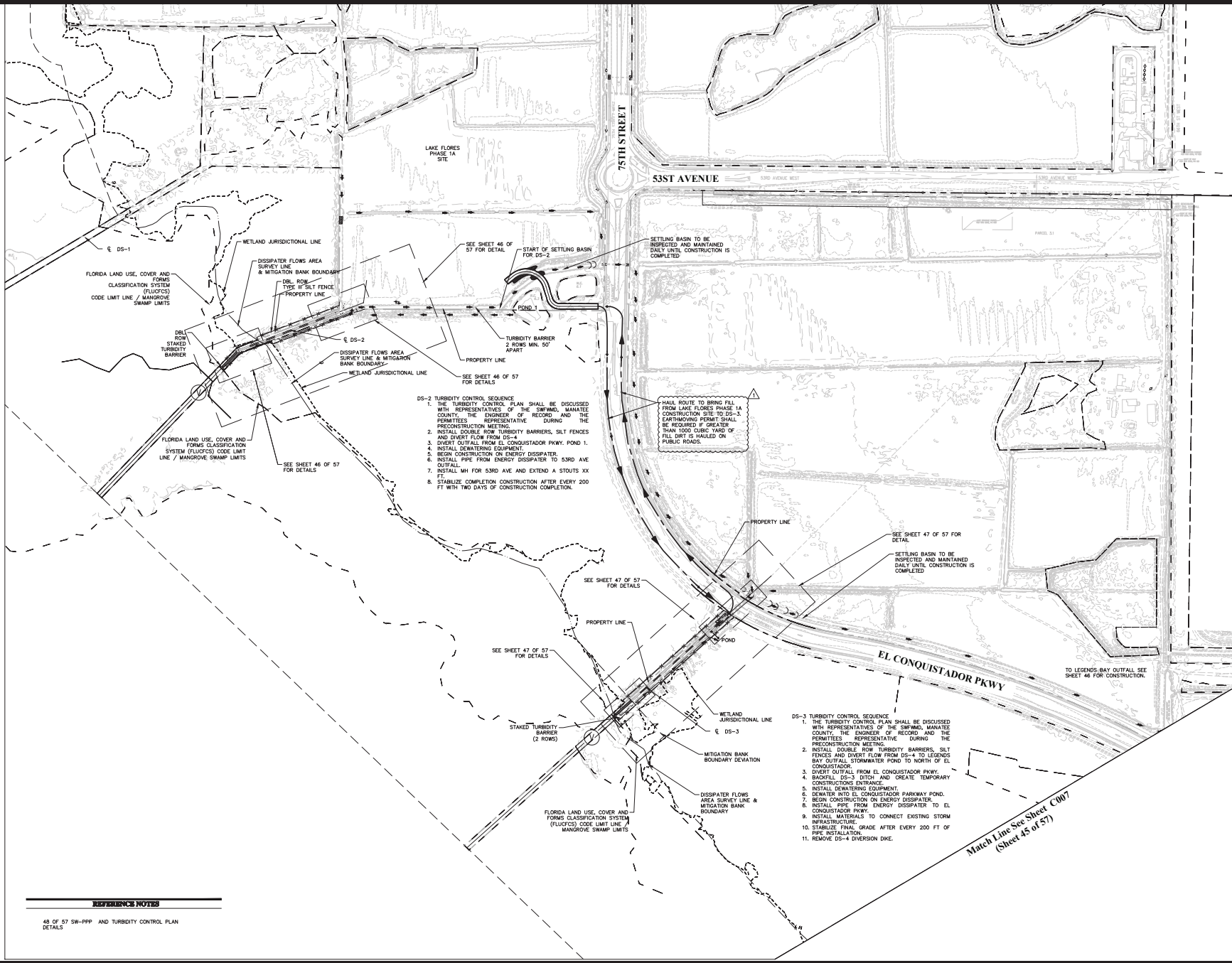

SEE SHEET 46 OF 57 FOR DETAIL

START OF SETTLING BASIN FOR DS-2

SETTLING BASIN TO BE INSPECTED AND MAINTAINED DAILY UNTIL CONSTRUCTION IS COMPLETED

SEE SHEET 46 OF 57 FOR DETAILS

SEE SHEET 46 OF 57 FOR DETAILS

- DS-2 TURBIDITY CONTROL SEQUENCE
1. THE TURBIDITY CONTROL PLAN SHALL BE DISCUSSED WITH REPRESENTATIVES OF THE SWFMD, MANATEE COUNTY, THE ENGINEER OF RECORD AND THE PERMITTEES REPRESENTATIVE DURING THE PRECONSTRUCTION MEETING.
 2. INSTALL DOUBLE ROW TURBIDITY BARRIERS, SILT FENCES AND DIVERT FLOW FROM DS-1.
 3. INSTALL DOUBLE ROW TURBIDITY BARRIERS, SILT FENCES AND DIVERT FLOW FROM EL CONQUISTADOR PKWY. POND 1.
 4. INSTALL SCUMMING EQUIPMENT.
 5. BEGIN CONSTRUCTION ON ENERGY DISSIPATER.
 6. INSTALL PIPE FROM ENERGY DISSIPATER TO 53RD AVE OUTFALL.
 7. INSTALL 14" FOR 53RD AVE AND EXTEND A STOUTS 30" FT.
 8. STABILIZE FINAL GRADE AFTER EVERY 200 FT WITH TWO DAYS OF CONSTRUCTION COMPLETION.

HALL ROUTE TO BRING FILL FROM LAKE FLORES PHASE 1A CONSTRUCTION SITE TO DS-3. EARTHMOVING PERMIT SHALL BE REQUIRED IF GREATER THAN 1000 CUBIC YARD OF FILL DIRT IS HAULED ON PUBLIC ROADS.

SEE SHEET 47 OF 57 FOR DETAIL

SEE SHEET 47 OF 57 FOR DETAIL

- DS-3 TURBIDITY CONTROL SEQUENCE
1. THE TURBIDITY CONTROL PLAN SHALL BE DISCUSSED WITH REPRESENTATIVES OF THE SWFMD, MANATEE COUNTY, THE ENGINEER OF RECORD AND THE PERMITTEES REPRESENTATIVE DURING THE PRECONSTRUCTION MEETING.
 2. INSTALL DOUBLE ROW TURBIDITY BARRIERS, SILT FENCES AND DIVERT FLOW FROM DS-4 TO LEGENDS BAY OUTFALL STORMWATER POND TO NORTH OF EL CONQUISTADOR.
 3. DIVERT OUTFALL FROM EL CONQUISTADOR PKWY.
 4. BACKFILL DS-3 DITCH AND CREATE TEMPORARY CONSTRUCTION ENTRANCE.
 5. INSTALL SCUMMING EQUIPMENT.
 6. DEMATER INTO EL CONQUISTADOR PARKWAY POND.
 7. BEGIN CONSTRUCTION ON ENERGY DISSIPATER.
 8. INSTALL PIPE FROM ENERGY DISSIPATER TO EL CONQUISTADOR POND.
 9. INSTALL MATERIALS TO CONNECT EXISTING STORM INFRASTRUCTURE.
 10. STABILIZE FINAL GRADE AFTER EVERY 200 FT OF PIPE INSTALLATION.
 11. REMOVE DS-4 DIVERSION DKE.

Match Line See Sheet C007 (Sheet 45 of 57)

REFERENCE NOTES

48 OF 57 SW-PPP AND TURBIDITY CONTROL PLAN DETAILS

P:\PROJECT FOLDERS\130317-02 - LAKE FLORES\CD\DWG PLAN SETS\SW-PPP\MANAGE_SHEETS\130317-02-005_3/7/2020_11:15 AM



CORNELIUS PROCTOR & CROSS

604 COURTLAND STREET SUITE 101
 PHONE : (407) 960-5980
 ORLANDO, FLORIDA 32804
 CERTIFICATE OF AUTHORIZATION # 2936

CIVIL ENGINEERING
 GEOMATICS
 CONSTRUCTION SERVICES
 EB# 3926

Legend

- PROPERTY LINE
- MITIGATION BANK BOUNDARY DEVIATION
- MITIGATION BANK BOUNDARY
- WETLAND JURISDICTIONAL LINE
- FLOODS LIMIT LINE / MANGROVE SWAMP LIMITS

0 40' 80'
 FULL SCALE: 1"=40'
 HALF SCALE: 1"=80'

ALL ELEVATIONS SHOWN ON THIS SHEET ARE BASED ON NAVD'83 DATUM CONVERSION (NAVD'83 + 0.99FT = NGVD'29)

No.	Revision	Date	App'd

Designed by **DH** Drawn by **SR** Checked by **DH**
 CAD checked by **DP** Approved by **DH**
 Scale **AS SHOWN** Date **October 2019**

**Lake Flores
 DS-2 & DS-3**

Project File

**Overall Site Plan
 DS-3**

Drawing Title

SHEET 50 OF 57

C101

Daniel J. Hayes State of Florida Professional Engineer License No. 88995 I have prepared and electronically signed and sealed by Daniel J. Hayes this set of drawings using digital signatures. Printed copies of these documents are not considered legal and valid and the signature must be verified on any electronic copies.	Project Number 130217.02
---	------------------------------------



P:\PROJECT FLORES\130217.02 - LAKE FLORES\CD\CD\PLAN SETS\CONSTRUCTION SETS\CONSTRUCTION SETS\130217.02-9905 1/25/2020 10:31 AM

SARASOTA BAY MEAN WATER LEVELS
 MHRL: 0.54'
 MHR: 0.25'
 MSL: -0.46'
 MLLS: -1.01'
 HURRICANE CATEGORY 1 WATER ELEV.: 12.0'



CARRAHAN PROCTOR & CROSS
 604 COURTLAND STREET SUITE 101
 PHONE : (407) 960-5980
 ORLANDO, FLORIDA 32804
 CERTIFICATE OF AUTHORIZATION # 2936

CIVIL ENGINEERING
 GEOMATICS
 CONSTRUCTION SERVICES
 EB# 3926

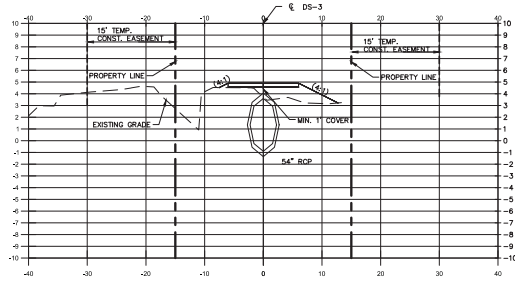

61+00.00

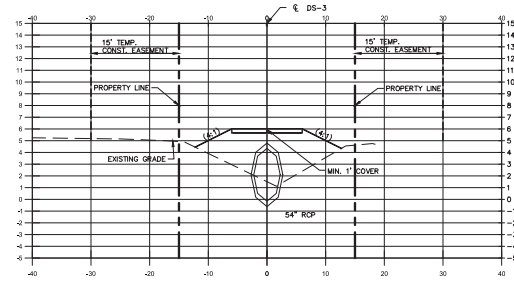

64+00.00

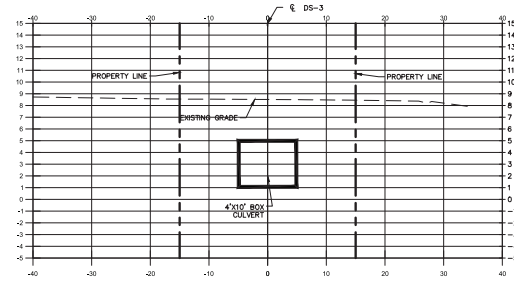

67+00.00

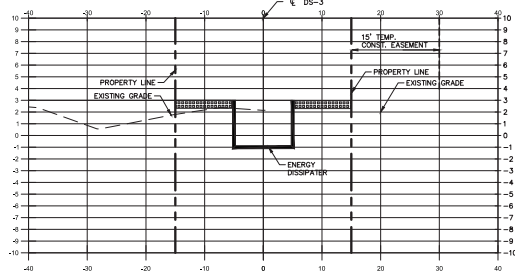

60+00.00

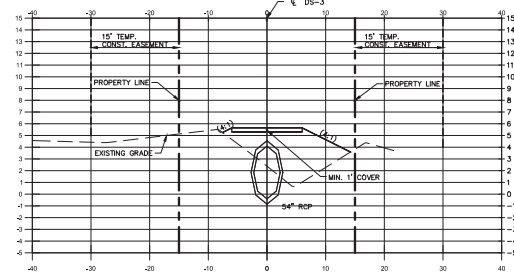

63+00.00

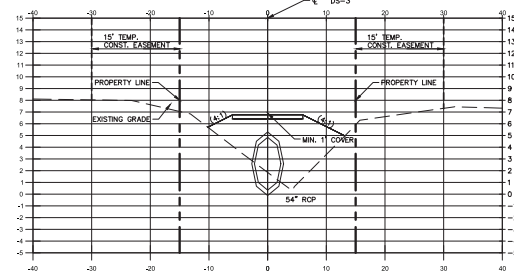

66+00.00

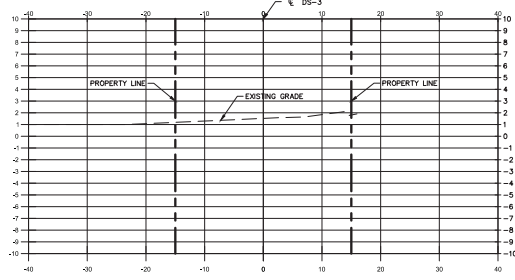

59+00.00

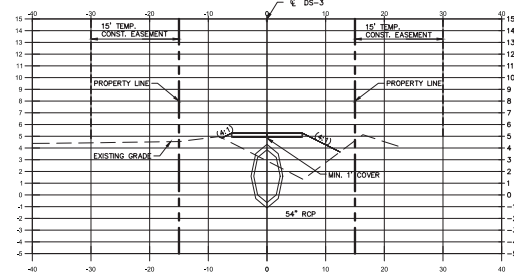

62+00.00

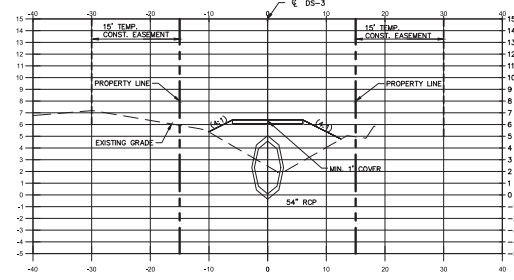

65+00.00

ALL ELEVATIONS SHOWN ON THIS SHEET ARE
 BASED ON NAVD'83 DATUM CONVERSION
 (NAVD'83 + 0.99FT = NGVD'29)

No.	Revision	Date	Apprd

Designed by **DH** Drawn by **SR** Checked by **DH**
 CAD checked by **DP** Approved by **DH**
 Scale **AS SHOWN** Date **October 2019**

Lake Flores DS-2 & DS-3

Project Title

Cross Sections DS-3

Drawing Title

SHEET 56 OF 57

C802

Daniel K. Hayes State of Florida Professional Engineer License No. 98995 <small>I have never been electronically signed and sealed by Daniel K. Hayes (P.E.) on any documents. Digital signatures: Printed copies of documents are not considered signed and sealed and this signature must be verified on any electronic copies.</small>	1/30/21/82 Project Number
	Project Number

P:\PROJECT FOLDERS\130217.02 - LAKE FLORES\CAD\PLAN SETS\CONFORMANCE SETS\130217.02C-C802 - 1/30/2020 10:34 AM

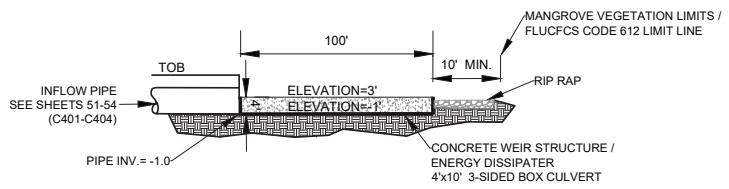

Longitudinal Cross Section of Dissipater

N.T.S.

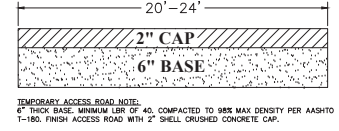

Stabilized Access/ Maintenance Drive

N.T.S.

RIP RAP NOTE:
RIP RAP SHALL BE 2.5' THICK AND INCLUDE ROCK SIZES BETWEEN 6"-12" DIAMETER LAID ON COMPACTED SOIL.

ENERGY DISSIPATER NOTE:
ENERGY DISSIPATER SHALL BE PREFABRICATED 3-SIDED BOX CULVERT OR APPROVED EQUAL. PROVIDE SIGNED AND SEALED STRUCTURAL SHOP DRAWINGS FOR APPROVAL BY ENGINEER OF RECORD. STRAIGHT CONCRETE ENDWALLS SHALL BE ADHERE TO FDOT STANDARDS INDEX 430-033 OR INCORPORATED INTO 3-SIDED BOX CULVERT DESIGN.
54" ENDWALL IS 21'-0" WIDE
72" ENDWALL IS 36'-0" WIDE BUT SHALL BE DESIGNED TO BE A MAXIMUM OF 30'-0".

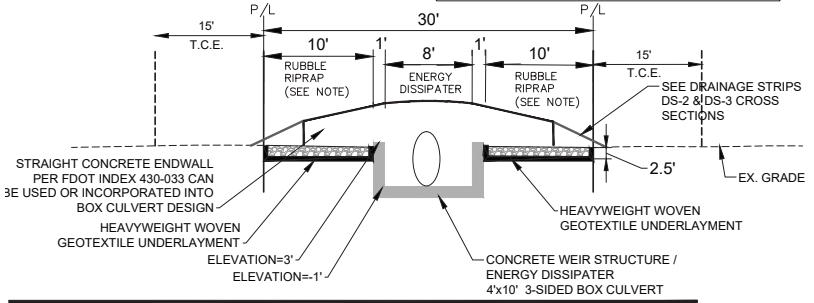

Drainage Strip Cross Section of Dissipater

N.T.S.

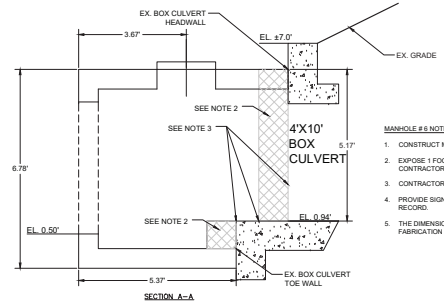

MANHOLE #6 NOTE:

1. CONSTRUCT MANHOLE IN ACCORDANCE WITH FOOT LATEST SPECIFICATION
2. EXPOSE 1 FOOT OF REINFORCING STEEL AFTER PROPER INSTALLATION OF MANHOLE. CONTRACTOR SHALL FORM AND POUR CONCRETE AROUND EXPOSED CONCRETE
3. CONTRACTOR SHALL WRAP ALL CONSTRUCTION JOINTS WITH FILTER FABRIC (TYPICAL)
4. PROVIDE SIGNED AND SEAL STRUCTURAL SHOP DRAWING FOR APPROVAL BY THE ENGINEER OF RECORD
5. THE DIMENSIONS OF THE BOX CULVERT SHALL BE FIELD VERIFIED BY THE CONTRACTOR PRIOR TO FABRICATION OF MANHOLE #6

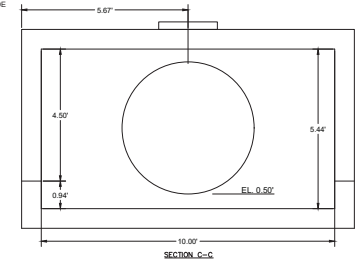
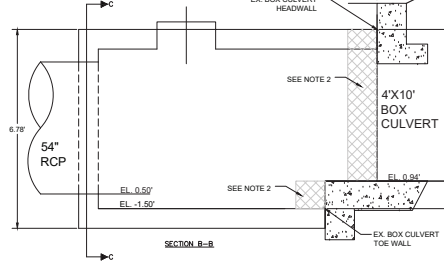
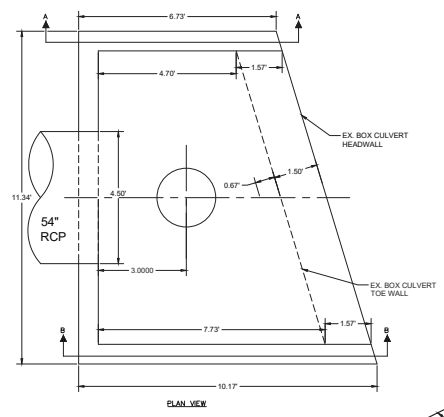

ALL ELEVATIONS SHOWN ON THIS SHEET ARE BASED ON NAVD'83 DATUM CONVERSION (NAVD'83 + 0.99FT = NGVD'29)

No.	Revision	Date	App'd

Designed by **DH** Drawn by **SR** Checked by **DH**
CAD checked by **DP** Approved by **DH**
Scale **AS SHOWN** Date **October 2019**

Lake Flores DS-2 & DS-3

Site Details

SHEET 57 OF 57
C900

Daniel A. Hayes
State of Florida
Professional Engineer
License No. 98895
130217.02
I HEREBY CERTIFY THAT I AM THE REGISTERED PROFESSIONAL ENGINEER AND SEALER OF THIS DOCUMENT AND THAT I AM NOT PROVIDING ENGINEERING SERVICES TO ANY OTHER PARTY.
Signature/Printed name of the Engineer
Date of the Document
Project Number

Drainage Strip (DS-2) Cross Section Prior to Dissipater

N.T.S.

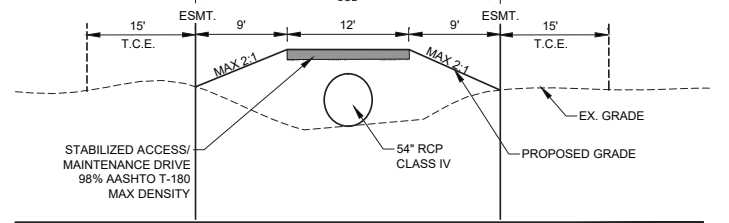

Drainage Strip (DS-3) Cross Section Prior to Dissipater

N.T.S.

Manhole MH-6 - Sta. 66+61.45

N.T.S.

DS-3 DRAINAGE STRIP SCHEDULE OF VALUES

	UNIT	QTY	UNIT COST	TOTAL
GENERAL CONDITIONS				
Mobilization	LS			
Install and monitor Silt Fence (BMP)	LF			
Certified As-built & record drawings	LS			
Construction Stake out	LS			
Permits/ permit fee's	LS			
Geotech	LS			
Performance & Payment Bond	LS			
SUBTOTAL GENERAL CONDITIONS:				
EARTHWORK				
Clearing & Grubbing	AC			
Import fill from Phase 1C (under 1,000 Cy)	CY			
Rough & Final Grading	SY			
Bahia Sod	SY			
SUBTOTAL EARTHWORK				
DRAINAGE				
30" RCP Class 3	LF			
54" RCP Class 4	LF			
MH-4 (JB)	EA			
MH-5- (JB)	EA			
MH-6- (JB)	EA			
Energy Dissipater	LS			
Rip Rap around Dissipater	LS			
Straight Concrete End wall 54"	EA			
Modify Box Culvert Headwall.	LS			
Misc pipe Connection's	LS			
Misc repairs	LS			

Testing	LF			
SUBTOTAL DRAINAGE				
DEMOLITION				
Demo existing structures & pipe	LS			
Demo Curb & Sidewalk	LS			
Demo Existing Geo-tech	LS			
SUBTOTAL DEMOLITION				
SITE WORK				
Construct Stabilized Access Maintenance Drive	EA	1		
Construct Soil Tracking Prevention Device	EA	2		
Construct new sidewalk and curbing	LS			
SUBTOTAL SITEWORK				

SUMMARY

SUBTOTAL GENERAL CONDITIONS

SUBTOTAL EARTHWORK

SUBTOTAL DRAINAGE

SUBTOTAL DEMOLITION

SUBTOTAL SITE WORK

GRAND TOTAL:

ID	Task Name	Duration	Start	Finish	Predecessors	22, '23							Oct 29, '23							Nov 5, '23						
						M	T	W	T	F	S	S	M	T	W	T	F	S	S	M	T	W	T			
1	DS-3 STRIP 10.24.23	181 days	Tue 10/24/23	Tue 7/2/24																						
2																										
3	PRE-CONSTRUCTION	103 days	Tue 10/24/23	Thu 3/14/24																						
4	Cortez/Engineer Project Administration	9 days	Tue 10/24/23	Fri 11/3/23																						
5	Public Notice	24 days	Mon 10/30/23	Thu 11/30/23	4FS-5 days																					
6	Bid Submittal	25 days	Tue 11/7/23	Mon 12/11/23	5FS-18 days																					
7	Bid Review	8 days	Tue 12/12/23	Thu 12/21/23	6																					
8	Execute Contract	15 days	Fri 12/22/23	Thu 1/11/24	7																					
9	Prepare Product Submittals	10 days	Fri 1/12/24	Thu 1/25/24	8																					
10	Order & Deliver Materials	40 days	Fri 1/19/24	Thu 3/14/24	9FS-5 days																					
11																										
12	SITE WORK & DRAINAGE	120 days	Wed 1/17/24	Tue 7/2/24																						
13	Mobilization	5 days	Wed 1/17/24	Tue 1/23/24	8FS+3 days																					
14	Silt fence & Turbidity Barrier	3 days	Wed 1/24/24	Fri 1/26/24	13																					
15	Clear and Grubbing	8 days	Mon 1/29/24	Wed 2/7/24	14																					
16	Energy Dissipater	20 days	Thu 2/8/24	Wed 3/6/24	15																					
17	Install outfall Manholes, pipe & Head walls	18 days	Thu 3/7/24	Mon 4/1/24	16																					
18	Stabilized Accesss/Maintenace Drive	6 days	Tue 4/2/24	Tue 4/9/24	17																					
19	Grading- Perimeter Sod	5 days	Wed 4/10/24	Tue 4/16/24	18																					
20	Testing, Asbuilts, Final sign off	15 days	Wed 4/17/24	Tue 5/7/24	19																					
21	SWFM/MC Certification	40 days	Wed 5/8/24	Tue 7/2/24	20																					

Project: DS-3 SCHEDULE 10.10.23
Date: Wed 10/25/23

Task Progress Summary External Tasks Deadline

Split Milestone Project Summary External Milestone

AGREEMENT BETWEEN OWNER AND CONTRACTOR FOR CONSTRUCTION CONTRACT (STIPULATED PRICE)

LAKE FLORES, DS-3

This Agreement is by and between Lake Flores Community Development District (“Owner”) and _____ (“Contractor”).

Terms used in this Agreement have the meanings stated in the General Conditions and the Supplementary Conditions.

Owner and Contractor hereby agree as follows:

ARTICLE 1—WORK

1.01 Contractor shall complete all Work as specified or indicated in the Contract Documents. The Work is generally described as follows: All labor, materials, equipment, services, and documentation necessary to construct the Project defined herein. The Work may include related services such as testing, start-up, and commissioning, all as required by the Contract Documents

ARTICLE 2—THE PROJECT

2.01 The Project, of which the Work under the Contract Documents is a part, is generally described as follows: [project description]

ARTICLE 3—ENGINEER

3.01 The Owner has retained ZNS Engineering, located at 1023 Manatee Ave. W. Bradenton, FL (“Engineer”) to act as Owner’s representative, assume all duties and responsibilities of Engineer, and have the rights and authority assigned to Engineer in the Contract.

3.02 The part of the Project that pertains to the Work has been designed by Engineer.

ARTICLE 4—CONTRACT TIMES

4.01 *Time is of the Essence*

A. All time limits for Milestones, if any, Substantial Completion, and completion and readiness for final payment as stated in the Contract Documents are of the essence of the Contract. The Work to be performed under this Agreement shall be commenced no later than ten (10) calendar days, including Saturdays, Sundays, and holidays, from the date of the Notice to Proceed.

4.02 *Contract Times: Days*

A. The Work will be substantially complete within _____ [days after the date when the Contract Times commence to run as provided in Paragraph 4.01 of the General Conditions, and completed and ready for final payment in accordance with Paragraph 15.06 of the General Conditions 30 days after the substantial completion date **and** delivery of the punch list items, per s. 218.735(7)(c)

4.03 *Liquidated Damages*

- A. Contractor and Owner recognize that time is of the essence as stated in Paragraph 4.01 above and that Owner will suffer financial and other losses if the Work is not completed within the Contract Times, as duly modified. The parties also recognize the delays, expense, and difficulties involved in proving, in a legal or arbitration proceeding, the actual loss suffered by Owner if the Work is not completed on time. The Owner and Contractor agree that an assessment of actual damages as of the date of this Agreement would be uncertain, and the amount of liquidated damages set forth herein is reasonable. Accordingly, instead of requiring any such proof of actual damages, Owner and Contractor agree that as liquidated damages for delay (but not as a penalty):
1. *Substantial Completion:* Contractor shall pay Owner \$1,000 for each day that expires after the time (as duly adjusted pursuant to the Contract) specified above for Substantial Completion, until the Work is substantially complete.
 2. *Completion of Remaining Work:* After Substantial Completion, if Contractor shall neglect, refuse, or fail to complete the remaining Work within the Contract Times (as duly adjusted pursuant to the Contract) for completion and readiness for final payment, Contractor shall pay Owner \$1,000 for each day that expires after such time until the Work is completed and ready for final payment.
 3. Liquidated damages for failing to timely attain Substantial Completion, and

ARTICLE 5—CONTRACT PRICE

- 5.01 Owner shall pay Contractor for completion of the Work in accordance with the Contract Documents, the amounts that follow, subject to adjustment under the Contract:
- A. For all Work other than Unit Price Work, a lump sum of \$ _____ [number].
All specific cash allowances are included in the above price in accordance with
- D. For all Work, including additions or changes to the Work, payment shall be made in accordance with ~~at~~ the prices stated in Contractor's Bid, attached hereto as an exhibit. Unit Pricing, as shown in the Contractor's Bid attached hereto, shall only be used in connection with pricing for change orders.

ARTICLE 6—PAYMENT PROCEDURES

6.01 *Submittal and Processing of Payments*

- A. Contractor shall submit Applications for Payment in accordance with Article 15 of the General Conditions. Applications for Payment will be processed by Engineer as provided in the General Conditions.

6.02 *Progress Payments; Retainage*

- A. Owner shall make progress payments on the basis of Contractor's Applications for Payment in a manner consistent with the Local Government Prompt Payment Act, sections 218.70 through 218.80 of the Florida Statutes. All such payments will be measured by the Schedule of Values established as provided in the General Conditions (and in the case of Unit Price Work based on the number of units completed) or, in the event there is no Schedule of Values, as provided elsewhere in the Contract. Five percent (5%) of the amount of each progress

payment shall be withheld as retainage until substantial completion of the Work. Within twenty (20) business days after the development of the punch list items and estimated cost to complete each punch list item, Owner shall pay the Contractor the remaining contract balance that includes all retainage previously withheld less an amount equal to one hundred-fifty percent (150%) of the estimated cost to complete the punch list items. Upon final completion and acceptance of the Work by the Owner, including satisfaction of all punch list requirements, and submission of all documents required under Paragraph 15.06 of the General Conditions, Owner shall pay the remaining outstanding balance, including the withheld amount pursuant to the sentence immediately preceding this, subject to any offsets to which the Owner is entitled.

6.03 *Final Payment*

- A. Upon final completion and acceptance of the Work, in accordance with Paragraph 15.06 of the General Conditions, and subject to final acceptance by [] County and/or the local utility provider, as applicable, Owner shall pay the remainder of the Contract Price as recommended by the Engineer and in accordance with Paragraph 15.06 of the General Conditions.

6.04 *Consent of Surety*

- A. Owner will not make final payment, or return or release retainage at Substantial Completion or any other time, unless Contractor submits written consent of the surety to such payment, return, or release.

6.05 *Interest*

- A. All payments due and not made within the time prescribed by Section 218.735, Florida Statutes, shall bear interest from thirty (30) days after the due date at the rate of two percent (2%) per month on the unpaid balance in accordance with Section 218.74, Florida Statutes.

ARTICLE 7—CONTRACT DOCUMENTS

7.01 *Contents*

- A. The Contract Documents consist of all of the following:
1. This Agreement as modified herein.
 2. Bonds:
 - a. Performance bond (together with power of attorney).
 - b. Payment bond (together with power of attorney).
 - c. Bid bond (together with power of attorney)
 3. General Conditions as modified therein.
 4. Supplementary Conditions Relating to Insurance Requirements, Subsurface Conditions, and Hazardous Conditions.
 5. Project Manual, including but not limited to Specifications as listed in the table of contents of the Project Manual (copy of list attached).
 7. Drawings listed on the attached sheet index.

8. Contract Addenda (numbers **[number]** to **[number]**, inclusive).
 9. Exhibits to this Agreement (enumerated as follows):
 - a. Contractor's Bid (Exhibit A)
 - b. Bid Addendum(s), if any
 - c. Technical Specifications page _____ through _____, inclusive
 10. The following which may be delivered or issued on or after the Effective Date of the Contract and are not attached hereto:
 - a. Notice to Proceed.
 - b. Work Change Directives.
 - c. Change Orders.
 - d. Field Orders.
 - e. Warranty Bond, if any.
- B. The Contract Documents listed in Paragraph 7.01.A are attached to this Agreement (except as expressly noted otherwise above).
- C. There are no Contract Documents other than those listed above in this Article 7.
- D. The Contract Documents may only be amended, modified, or supplemented as provided in the Contract.

ARTICLE 8—REPRESENTATIONS, CERTIFICATIONS, AND STIPULATIONS

8.01 Contractor's Representations

- A. In order to induce Owner to enter into this Contract, Contractor makes the following representations:
1. Contractor has examined and carefully studied the Contract Documents, including Addenda, if any.
 2. Contractor has visited the Site, conducted a thorough visual examination of the Site and adjacent areas, and become familiar with the general, local, and Site conditions that may affect cost, progress, and performance of the Work.
 3. Contractor is familiar with all Laws and Regulations that may affect cost, progress, and performance of the Work.
 4. Contractor has carefully studied the reports of explorations and tests of subsurface conditions at or adjacent to the Site and the drawings of physical conditions relating to existing surface or subsurface structures at the Site that have been identified in the Supplementary Conditions, if any, with respect to the Technical Data in such reports and drawings.
 5. Contractor has carefully studied the reports and drawings relating to Hazardous Environmental Conditions, if any, at or adjacent to the Site that have been identified in the Supplementary Conditions, with respect to Technical Data in such reports and drawings.

6. Contractor has considered the information known to Contractor itself; information commonly known to contractors doing business in the locality of the Site; information and observations obtained from visits to the Site; the Contract Documents; and the Technical Data identified in the Supplementary Conditions or by definition, with respect to the effect of such information, observations, and Technical Data on (a) the cost, progress, and performance of the Work; (b) the means, methods, techniques, sequences, and procedures of construction to be employed by Contractor; and (c) Contractor's safety precautions and programs.
7. Based on the information and observations referred to in the preceding paragraph, Contractor agrees that no further examinations, investigations, explorations, tests, studies, or data are necessary for the performance of the Work at the Contract Price, within the Contract Times, and in accordance with the other terms and conditions of the Contract.
8. Contractor is aware of the general nature of work to be performed by Owner and others at the Site that relates to the Work as indicated in the Contract Documents.
9. Contractor has given Engineer written notice of all conflicts, errors, ambiguities, or discrepancies that Contractor has discovered in the Contract Documents, and of discrepancies between Site conditions and the Contract Documents, and the written resolution thereof by Engineer is acceptable to Contractor.
10. The Contract Documents are generally sufficient to indicate and convey an understanding of all terms and conditions for performance and furnishing of the Work.
11. Contractor's entry into this Contract constitutes an incontrovertible representation by Contractor that without exception all prices in the Agreement are premised upon performing and furnishing the Work required by the Contract Documents.
12. Contractor is financially solvent, able to pay its debts as they mature and possesses sufficient working capital (subject to payments by Owner required under this Agreement) to complete the Work required to be performed of it under this Contract.
13. Contractor is able to furnish (directly or by subcontract or through vendors) any plant, tools, materials, supplies, equipment and labor necessary to complete the services required of Contractor under this Contract and Contractor has sufficient experience and competence to perform the Work under the Contract.
14. Contractor is authorized to do business in the State of Florida and is properly licensed (to the extent required by law) by all necessary governmental authorities having jurisdiction over the Work.

8.02 *Contractor's Certifications*

- A. Contractor certifies that it has not engaged in corrupt, fraudulent, collusive, or coercive practices in competing for or in executing the Contract. For the purposes of this Paragraph 8.02:
 1. "corrupt practice" means the offering, giving, receiving, or soliciting of anything of value likely to influence the action of a public official in the bidding process or in the Contract execution;

2. “fraudulent practice” means an intentional misrepresentation of facts made (a) to influence the bidding process or the execution of the Contract to the detriment of Owner, (b) to establish Bid or Contract prices at artificial non-competitive levels, or (c) to deprive Owner of the benefits of free and open competition;
3. “collusive practice” means a scheme or arrangement between two or more Bidders, with or without the knowledge of Owner, a purpose of which is to establish Bid prices at artificial, non-competitive levels; and
4. “coercive practice” means harming or threatening to harm, directly or indirectly, persons or their property to influence their participation in the bidding process or affect the execution of the Contract.

8.03 *Standard General Conditions*

- A. Owner stipulates that if the General Conditions that are made a part of this Contract are EJCDC® C-700, Standard General Conditions for the Construction Contract (2018), published by the Engineers Joint Contract Documents Committee, and if Owner is the party that has furnished said General Conditions, then Owner has plainly shown all modifications to the standard wording of such published document to the Contractor, through a process such as highlighting or “track changes” (redline/strikeout), and/or in the Supplementary Conditions.

ARTICLE 9—MISCELLANEOUS

9.01 *Terms*

- A. Terms used in the Agreement will have the meanings stated in the General Conditions and the Supplementary Conditions unless otherwise stated herein.

9.02 *Assignment of Contract*

- A. Unless expressly agreed to elsewhere in the Contract, no assignment by a party hereto of any rights under or interests in the Contract will be binding on another party hereto without the written consent of the party sought to be bound; and, specifically but without limitation, money that may become due and money that is due may not be assigned without such consent (except to the extent that the effect of this restriction may be limited by law), and unless specifically stated to the contrary in any written consent to an assignment, no assignment will release or discharge the assignor from any duty or responsibility under the Contract Documents.

9.03 *Successors and Assigns*

- A. Owner and Contractor each binds itself, its partners, successors, assigns, and legal representatives to the other party hereto, its partners, successors, assigns, and legal representatives in respect to all covenants, agreements, and obligations contained in the Contract Documents.

9.04 *Public Records*

- A. The Contractor understands and agrees that all documents of any kind provided to the District in connection with this Contract may be public records, and, accordingly, Contractor agrees to comply with all applicable provisions of Florida law in handling such records, including but not limited to Section 119.0701, Florida Statutes. Contractor acknowledges that the

EJCDC® C-520, Agreement between Owner and Contractor for Construction Contract (Stipulated Price).
Copyright® 2018 National Society of Professional Engineers, American Council of Engineering Companies,
and American Society of Civil Engineers. All rights reserved.

designated public records custodian for the District is [REDACTED] (“Public Records Custodian”). Among other requirements and to the extent applicable by law, the Contractor shall:

- 1) keep and maintain public records required by the District to perform the service;
- 2) upon request by the Public Records Custodian, provide the District with the requested public records or allow the records to be inspected or copied within a reasonable time period at a cost that does not exceed the cost provided in Chapter 119, Florida Statutes;
- 3) ensure that public records which are exempt or confidential, and exempt from public records disclosure requirements, are not disclosed except as authorized by law for the duration of the contract term and following the contract term if the Contractor does not transfer the records to the Public Records Custodian of the District; and
- 4) upon completion of the contract, transfer to the District, at no cost, all public records in Contractor’s possession or, alternatively, keep, maintain and meet all applicable requirements for retaining public records pursuant to Florida laws. When such public records are transferred by the Contractor, the Contractor shall destroy any duplicate public records that are exempt or confidential and exempt from public records disclosure requirements. All records stored electronically must be provided to the District in a format that is compatible with Microsoft Word or Adobe PDF formats.

IF THE CONTRACTOR HAS QUESTIONS REGARDING THE APPLICATION OF CHAPTER 119, FLORIDA STATUTES, TO THE CONTRACTOR'S DUTY TO PROVIDE PUBLIC RECORDS RELATING TO THIS AGREEMENT, CONTACT THE CUSTODIAN OF PUBLIC RECORDS AT [REDACTED], TELEPHONE: () [REDACTED] - [REDACTED], FAX: () [REDACTED] - [REDACTED], OR EMAIL: [REDACTED]@ [REDACTED].COM.

9.05 Assignment of Warranties

- A. Contractor shall assign to Owner all warranties extended to Contractor by material suppliers and subcontractors. If an assignment of warranty requires the material supplier and/or subcontractor to consent to same, then Contractor shall secure the material supplier’s and/or subcontractor’s consent to assign said warranties to Owner.

9.06 Construction Defects

- A. CLAIMS FOR CONSTRUCTION DEFECTS ARE NOT SUBJECT TO THE NOTICE AND CURE PROVISIONS OF CHAPTER 558, FLORIDA STATUTES.

9.07 Restriction on Removal of Fill Dirt from Work Site

- A. Contractor acknowledges that all suitable soil/fill material shall remain on-site. Fill material shall not be removed from the Project site without the written consent of the Owner.

9.08 Public Entity Crimes

- A. Pursuant to Section 287.133(3)(a), Florida Statutes:

A person or affiliate who has been placed on the convicted vendor list following a conviction for a public entity crime may not submit a bid, proposal, or reply on a contract to provide any goods or services to a public entity; may not submit a bid, proposal, or reply on a contract with a public entity for the construction or repair of a public building or public work; may not submit bids, proposals, or replies on leases of real property to a public entity; may not be awarded or perform work as a contractor, supplier, subcontractor, or consultant under a contract with any public entity; and may not transact business with any public entity in excess of the threshold amount provided in s. 287.017 for CATEGORY TWO for a period of 36 months following the date of being placed on the convicted vendor list.

Contractor represents that in entering into this Contract, the Contractor has not been placed on the convicted vendor list within the last 36 months and, in the event that the Contractor is placed on the convicted vendor list, the Contractor shall immediately notify the Owner whereupon this Contract may be terminated by the Owner.

9.09 *Scrutinized Companies*

Contractor represents that in entering into this Contract, neither it nor any of its officers, directors, executives, partners, shareholders, members, or agents is on the Scrutinized Companies with Activities in Sudan List or the Scrutinized Companies with Activities in the Iran Petroleum Energy Sector List, created pursuant to Section 215.473, Florida Statutes, and in the event such status changes, Contractor shall immediately notify Owner.

9.10 *Counterparts; Electronic Signatures*

This Agreement may be executed in any number of counterparts, each of which when executed and delivered shall be an original; however, all such counterparts together shall constitute, but one and the same instrument. Additionally, the parties acknowledge and agree that this Agreement may be executed by electronic signature, which shall be considered as an original signature for all purposes and shall have the same force and effect as an original signature. Without limitation, "electronic signature" shall include faxed versions of an original signature, electronically scanned and transmitted versions (e.g. via PDF) of an original signature, or signatures created in a digital format.

9.11 *E-Verify.*

The Contractor shall comply with and perform all provisions of Section 448.095, Florida Statutes. Accordingly, as a condition precedent to entering into this Agreement, Contractor shall register with and use the United States Department of Homeland Security's E-Verify system to verify the work authorization status of all newly hired employees.

If the Contractor anticipates entering into agreements with a subcontractor for the Work, Contractor will not enter into the subcontractor agreement without first receiving an affidavit from the subcontractor regarding compliance with Section 448.095 and stating that the subcontractor has registered with and uses the E-Verify system and does not employ, contract with, or subcontract with an unauthorized alien. Contractor shall maintain a copy of such affidavit for the duration of the agreement and provide a copy to the Owner upon request. Any party may terminate this Agreement or any subcontract hereunder if there is a good faith belief on the part of the terminating party that a contracting party has knowingly violated Section 448.09(1), Florida

Statutes. Upon such termination, Contractor shall be liable for any additional costs incurred by Owner as a result of the termination.

In the event that the Owner has a good faith belief that a subcontractor has violated Section 448.095, but the Contractor has otherwise complied with its obligations hereunder, the Owner shall promptly notify the Contractor. The Contractor agrees to immediately terminate the agreement with the subcontractor upon notice from the Owner.

9.12 Direct Purchase of Materials

- A. Owner represents to Contractor that Owner is a governmental entity exempt from Florida sales and use tax, and will provide Contractor with a copy of its Consumer Exemption Certificate. Owner may elect to implement a direct purchase arrangement whereby Owner will directly acquire certain materials (“Direct Purchase Materials”) necessary for the completion of the Work directly from the suppliers to take advantage of Owner’s tax-exempt status.
- B. Within 10 days of the issuance of the Notice to Proceed or other written authorization for Work, Owner shall provide Contractor with a list of materials that will be treated as Direct Purchase Materials.
- C. Owner shall issue purchase orders directly to suppliers of Direct Purchase Materials. Such purchase orders shall include Owner’s consumer certificate of exemption number and shall require that the supplier provide the required shipping and handling insurance and provide for delivery with title and risk of loss transferring upon delivery at the jobsite and after acceptance by Owner. Corresponding change orders shall be executed at the time of the direct purchase to reflect the direct purchases made by the Owner and if the original contract contemplated sale of materials and installation by same person, the change order needs to reflect sale of materials and installation by different legal entities.
- D. Owner shall issue a Certificate of Entitlement to each supplier of Direct Purchase Materials, and furnish a copy of same to the Contractor. Each Certificate of Entitlement must have attached thereto the corresponding purchase order. Each Certificate of Entitlement shall acknowledge that if the Department of Revenue determines the purchase is not a tax-exempt purchase by a governmental entity, then the governmental entity will be responsible for any tax, penalties and interest determined to be due. Each Certificate of Entitlement shall affirm that (1) the attached purchase order is being issued directly to the vendor supplying the tangible personal property the Contractor will use in the identified public works; (2) the vendor’s invoice will be issued directly to the governmental entity; (3) payment of the vendor’s invoice will be made directly by the governmental entity to the vendor from public funds; (4) the governmental entity will take title to the tangible personal property from the vendor at the time of delivery by the vendor; and (5) the governmental entity assumes the risk of damage or loss at the time of delivery by the vendor.
- E. Upon delivery of the Direct Purchase Materials to the jobsite, the Owner, through Contractor as its agent, shall inspect the materials and invoices to determine that they conform to the purchase order. If the materials conform, Owner shall accept and take title to the Direct Purchase Materials through its agent, which is Contractor.
- F. Suppliers shall issue invoices directly to Owner. Owner shall process invoices and issue payment directly to the suppliers.

G. Upon acceptance of Direct Purchase Materials, Owner shall assume risk of loss of same until they are incorporated into the Project. Contractor, as Owner's agent, shall be responsible for safeguarding all Direct Purchase Materials and for obtaining and managing all warranties and guarantees for all material and products as required under the Contract Documents. All warranties provided by Contractor as part of Contract shall apply to all Direct Purchase Materials, as though Contractor had purchased the Direct Purchase Materials.

[Signatures on following page]

IN WITNESS WHEREOF, Owner and Contractor have signed this Agreement.

This Agreement will be effective on _____ (which is the Effective Date of the Contract).

Owner: _____
Community Development District
(typed or printed name of organization)

By: _____
(individual's signature)

Date: _____
(date signed)

Name: _____
(typed or printed)

Title: Chairperson, Board of Supervisors
(typed or printed)

Attest: _____
(individual's signature)

Title: _____
(typed or printed)

Address for giving notices:

Designated Representative:

Name: _____

Title: _____
(typed or printed)

Address: _____

Phone: _____

Email: _____

(If [Type of Entity] is a corporation, attach evidence of authority to sign. If [Type of Entity] is a public body, attach evidence of authority to sign and resolution or other documents authorizing execution of this Agreement.)

Contractor: _____
(typed or printed name of organization)

By: _____
(individual's signature)

Date: _____
(date signed)

Name: _____
(typed or printed)

Title: _____
(typed or printed)

(If [Type of Entity] is a corporation, a partnership, or a joint venture, attach evidence of authority to sign.)

Attest: _____
(individual's signature)

Title: _____
(typed or printed)

Address for giving notices:

Designated Representative:

Name: _____
(typed or printed)

Title: _____
(typed or printed)

Address: _____

Phone: _____

Email: _____

License No.: _____
(where applicable)

State: _____

STANDARD GENERAL CONDITIONS OF THE CONSTRUCTION CONTRACT

TABLE OF CONTENTS

	Page
Article 1—Definitions and Terminology	1
1.01 Defined Terms	1
1.02 Terminology	6
Article 2—Preliminary Matters	7
2.01 Delivery of Performance and Payment Bonds; Evidence of Insurance	7
2.02 Copies of Documents	8
2.03 Before Starting Construction	8
2.04 Preconstruction Conference; Designation of Authorized Representatives	8
2.05 Acceptance of Schedules	8
2.06 Electronic Transmittals	9
Article 3—Contract Documents: Intent, Requirements, Reuse	9
3.01 Intent	9
3.02 Reference Standards	10
3.03 Reporting and Resolving Discrepancies	10
3.04 Requirements of the Contract Documents	11
3.05 Reuse of Documents	12
Article 4—Commencement and Progress of the Work	12
4.01 Commencement of Contract Times; Notice to Proceed	12
4.02 Starting the Work	12
4.03 Reference Points	12
4.04 Progress Schedule	12
4.05 Delays in Contractor’s Progress	13
Article 5—Site; Subsurface and Physical Conditions; Hazardous Environmental Conditions	15
5.01 Availability of Lands	15
5.02 Use of Site and Other Areas	15
5.03 Subsurface and Physical Conditions	16
5.04 Differing Subsurface or Physical Conditions	18

5.05	Underground Facilities.....	19
5.06	Hazardous Environmental Conditions at Site	21
Article 6—Bonds and Insurance		24
6.01	Performance, Payment, and Other Bonds.....	24
6.02	Insurance—General Provisions.....	25
6.03	Contractor’s Insurance	26
6.04	Builder’s Risk and Other Property Insurance.....	27
6.05	Property Losses; Subrogation	28
6.06	Receipt and Application of Property Insurance Proceeds	29
Article 7—Contractor’s Responsibilities		30
7.01	Contractor’s Means and Methods of Construction	30
7.02	Supervision and Superintendence	30
7.03	Labor; Working Hours.....	30
7.04	Services, Materials, and Equipment	31
7.05	“Or Equals”	31
7.06	Substitutes	32
7.07	Concerning Subcontractors and Suppliers.....	34
7.08	Patent Fees and Royalties.....	35
7.09	Permits.....	36
7.10	Taxes.....	36
7.11	Laws and Regulations	36
7.12	Record Documents	37
7.13	Safety and Protection	37
7.14	Hazard Communication Programs.....	38
7.15	Emergencies.....	38
7.16	Submittals.....	38
7.17	Contractor’s General Warranty and Guarantee	41
7.18	Indemnification.....	42
7.19	Delegation of Professional Design Services	43
Article 8—Other Work at the Site		44
8.01	Other Work.....	44
8.02	Coordination	45
8.03	Legal Relationships	45

Article 9—Owner’s Responsibilities.....	46
9.01 Communications to Contractor	46
9.02 Replacement of Engineer.....	47
9.03 Furnish Data.....	47
9.04 Pay When Due	47
9.05 Lands and Easements; Reports, Tests, and Drawings.....	47
9.06 Insurance	47
9.07 Change Orders	47
9.08 Inspections, Tests, and Approvals.....	47
9.09 Limitations on Owner’s Responsibilities	47
9.10 Undisclosed Hazardous Environmental Condition.....	47
9.11 Evidence of Financial Arrangements	47
9.12 Safety Programs.....	48
Article 10—Engineer’s Status During Construction	48
10.01 Owner’s Representative	48
10.02 Visits to Site	48
10.03 Resident Project Representative	48
10.04 Engineer’s Authority	48
10.05 Determinations for Unit Price Work	49
10.06 Decisions on Requirements of Contract Documents and Acceptability of Work	49
10.07 Limitations on Engineer’s Authority and Responsibilities.....	49
10.08 Compliance with Safety Program	50
Article 11—Changes to the Contract.....	50
11.01 Amending and Supplementing the Contract	50
11.02 Change Orders	50
11.03 Work Change Directives.....	51
11.04 Field Orders	51
11.05 Owner-Authorized Changes in the Work.....	51
11.06 Unauthorized Changes in the Work.....	52
11.07 Change of Contract Price	52
11.08 Change of Contract Times.....	53
11.09 Change Proposals.....	53
11.10 Notification to Surety	54

Article 12—Claims	54
12.01 Claims	54
Article 13—Cost of the Work; Allowances; Unit Price Work	56
13.01 Cost of the Work.....	56
13.02 Allowances.....	59
13.03 Unit Price Work.....	60
Article 14—Tests and Inspections; Correction, Removal, or Acceptance of Defective Work.....	60
14.01 Access to Work	60
14.02 Tests, Inspections, and Approvals.....	61
14.03 Defective Work	61
14.04 Acceptance of Defective Work	62
14.05 Uncovering Work	62
14.06 Owner May Stop the Work	63
14.07 Owner May Correct Defective Work	63
Article 15—Payments to Contractor; Set-Offs; Completion; Correction Period.....	64
15.01 Progress Payments	64
15.02 Contractor’s Warranty of Title.....	67
15.03 Substantial Completion.....	67
15.04 Partial Use or Occupancy.....	68
15.05 Final Inspection.....	69
15.06 Final Payment	69
15.07 Waiver of Claims	70
15.08 Correction Period.....	71
Article 16—Suspension of Work and Termination	72
16.01 Owner May Suspend Work	72
16.02 Owner May Terminate for Cause.....	72
16.03 Owner May Terminate for Convenience	73
16.04 Contractor May Stop Work or Terminate.....	74
Article 17—Final Resolution of Disputes	74
17.01 Methods and Procedures	74
Article 18—Miscellaneous.....	75
18.01 Giving Notice.....	75
18.02 Computation of Times	75

18.03	Cumulative Remedies	75
18.04	Limitation of Damages.....	76
18.05	No Waiver	76
18.06	Survival of Obligations	76
18.07	Controlling Law	76
18.08	Assignment of Contract	76
18.09	Successors and Assigns	76
18.10	Headings	76

STANDARD GENERAL CONDITIONS OF THE CONSTRUCTION CONTRACT

[CDD/PROJECT NAME]

ARTICLE 1—DEFINITIONS AND TERMINOLOGY

1.01 Defined Terms

- A. Wherever used in the Bidding Requirements or Contract Documents, a term printed with initial capital letters, including the term's singular and plural forms, will have the meaning indicated in the definitions below. In addition to terms specifically defined, terms with initial capital letters in the Contract Documents include references to identified articles and paragraphs, and the titles of other documents or forms.
1. *Addenda*—Written or graphic instruments issued prior to the opening of Bids which clarify, correct, or change the Bidding Requirements or the proposed Contract Documents.
 2. *Agreement*—The written instrument, executed by Owner and Contractor, that sets forth the Contract Price and Contract Times, identifies the parties and the Engineer, and designates the specific items that are Contract Documents.
 3. *Application for Payment*—The document prepared by Contractor, in a form acceptable to Engineer, to request progress or final payments, and which is to be accompanied by such supporting documentation as is required by the Contract Documents.
 4. *Bid*—The offer of a Bidder submitted on the prescribed form setting forth the prices for the Work to be performed.
 5. *Bidder*—An individual or entity that submits a Bid to Owner.
 6. *Bidding Documents*—The Bidding Requirements, the proposed Contract Documents, and all Addenda.
 7. *Bidding Requirements*—The Advertisement or invitation to bid, the project manual and any documents included or referenced therein, including but not limited to Instructions to Bidders, Bid Bond or other Bid security, if any, the Bid Form, and the Bid with any attachments.
 8. *Change Order*—A document which is signed by Contractor and Owner and authorizes an addition, deletion, or revision in the Work or an adjustment in the Contract Price or the Contract Times, or other revision to the Contract, issued on or after the Effective Date of the Contract.
 9. *Change Proposal*—A written request by Contractor, duly submitted in compliance with the procedural requirements set forth herein, seeking an adjustment in Contract Price or Contract Times; contesting an initial decision by Engineer concerning the requirements of the Contract Documents or the acceptability of Work under the Contract Documents;

challenging a set-off against payments due; or seeking other relief with respect to the terms of the Contract.

10. *Claim*

- a. A demand or assertion by Owner directly to Contractor, duly submitted in compliance with the procedural requirements set forth herein, seeking an adjustment of Contract Price or Contract Times; contesting an initial decision by Engineer concerning the requirements of the Contract Documents or the acceptability of Work under the Contract Documents; contesting Engineer's decision regarding a Change Proposal; seeking resolution of a contractual issue that Engineer has declined to address; or seeking other relief with respect to the terms of the Contract.
- b. A demand or assertion by Contractor directly to Owner, duly submitted in compliance with the procedural requirements set forth herein, contesting Engineer's decision regarding a Change Proposal, or seeking resolution of a contractual issue that Engineer has declined to address.
- c. A demand or assertion by Owner or Contractor, duly submitted in compliance with the procedural requirements set forth herein, made pursuant to Paragraph 12.01.A.4, concerning disputes arising after Engineer has issued a recommendation of final payment.
- d. A demand for money or services by a third party is not a Claim.

11. *Constituent of Concern*—Asbestos, petroleum, radioactive materials, polychlorinated biphenyls (PCBs), lead-based paint (as defined by the HUD/EPA standard), hazardous waste, and any substance, product, waste, chemical, element, compound, solution, mixture, or other material of any nature whatsoever that is or becomes listed, regulated, or addressed pursuant to Laws and Regulations regulating, relating to, or imposing liability or standards of conduct concerning, any hazardous, toxic, or dangerous waste, substance, chemical, element, compound, solution, mixture, or material.

12. *Contract*—The entire and integrated written contract between Owner and Contractor concerning the Work.

13. *Contract Documents*—Those items so designated in the Agreement, and which together comprise the Contract.

14. *Contract Price*—The money that Owner has agreed to pay Contractor for completion of the Work in accordance with the Contract Documents.

15. *Contract Times*—The number of days or the dates by which Contractor shall: (a) achieve Milestones, if any; (b) achieve Substantial Completion; and (c) complete the Work.

16. *Contractor*—The individual or entity with which Owner has contracted for performance of the Work.

17. *Cost of the Work*—See Paragraph 13.01 for definition.

18. *Drawings*—The part of the Contract that graphically shows the scope, extent, and character of the Work to be performed by Contractor.

19. *Effective Date of the Contract*—The date, indicated in the Agreement, on which the Contract becomes effective.

20. *Electronic Document*—Any Project-related correspondence, attachments to correspondence, data, documents, drawings, information, or graphics, including but not limited to Shop Drawings and other Submittals, that are in an electronic or digital format.
21. *Electronic Means*—Electronic mail (email), upload/download from a secure Project website, or other communications methods that allow: (a) the transmission or communication of Electronic Documents; (b) the documentation of transmissions, including sending and receipt; (c) printing of the transmitted Electronic Document by the recipient; (d) the storage and archiving of the Electronic Document by sender and recipient; and (e) the use by recipient of the Electronic Document for purposes permitted by this Contract. Electronic Means does not include the use of text messaging, or of Facebook, Twitter, Instagram, or similar social media services for transmission of Electronic Documents.
22. *Engineer*—The individual or entity named as such in the Agreement.
23. *Field Order*—A written order issued by Engineer which requires minor changes in the Work but does not change the Contract Price or the Contract Times.
24. *Hazardous Environmental Condition*—The presence at the Site of Constituents of Concern in such quantities or circumstances that may present a danger to persons or property exposed thereto.
- a. The presence at the Site of materials that are necessary for the execution of the Work, or that are to be incorporated into the Work, and that are controlled and contained pursuant to industry practices, Laws and Regulations, and the requirements of the Contract, is not a Hazardous Environmental Condition.
 - b. The presence of Constituents of Concern that are to be removed or remediated as part of the Work is not a Hazardous Environmental Condition.
 - c. The presence of Constituents of Concern as part of the routine, anticipated, and obvious working conditions at the Site, is not a Hazardous Environmental Condition.
25. *Laws and Regulations; Laws or Regulations*—Any and all applicable laws, statutes, rules, regulations, ordinances, codes, and binding decrees, resolutions, and orders of any and all governmental bodies, agencies, authorities, and courts having jurisdiction. Such definitions shall further include, where the context reasonably allows, compliance with any applicable permits and/or other similar approvals issued by governmental bodies, agencies, and authorities.
26. *Liens*—Charges, security interests, or encumbrances upon Contract-related funds, real property, or personal property.
27. *Milestone*—A principal event in the performance of the Work that the Contract requires Contractor to achieve by an intermediate completion date, or by a time prior to Substantial Completion of all the Work.
28. *Notice of Award*—The written notice by Owner to a Bidder of Owner’s acceptance of the Bid.
29. *Notice to Proceed*—A written notice by Owner or Engineer to Contractor fixing the date on which the Contract Times will commence to run and on which Contractor shall start to perform the Work.

30. *Owner*—The individual or entity with which Contractor has contracted regarding the Work, and which has agreed to pay Contractor for the performance of the Work, pursuant to the terms of the Contract. The Owner may also be referred to as the “District.”
31. *Progress Schedule*—A schedule, prepared and maintained by Contractor, describing the sequence and duration of the activities comprising Contractor’s plan to accomplish the Work within the Contract Times.
32. *Project*—The total undertaking to be accomplished for Owner by engineers, contractors, and others, including planning, study, design, construction, testing, commissioning, and start-up, and of which the Work to be performed under the Contract Documents is a part.
33. *Resident Project Representative* —The authorized representative of Engineer assigned to assist Engineer at the Site. As used herein, the term Resident Project Representative (RPR) includes any assistants or field staff of Resident Project Representative.
34. *Samples*—Physical examples of materials, equipment, or workmanship that are representative of some portion of the Work and that establish the standards by which such portion of the Work will be judged.
35. *Schedule of Submittals*—A schedule, prepared and maintained by Contractor, of required submittals and the time requirements for Engineer’s review of the submittals.
36. *Schedule of Values*—A schedule, prepared and maintained by Contractor, allocating portions of the Contract Price to various portions of the Work and used as the basis for reviewing Contractor’s Applications for Payment.
37. *Shop Drawings*—All drawings, diagrams, illustrations, schedules, and other data or information that are specifically prepared or assembled by or for Contractor and submitted by Contractor to illustrate some portion of the Work. Shop Drawings, whether approved or not, are not Drawings and are not Contract Documents.
38. *Site*—Lands or areas indicated in the Contract Documents as being furnished by Owner upon which the Work is to be performed, including rights-of-way and easements, and such other lands or areas furnished by Owner which are designated for the use of Contractor.
39. *Specifications*—The part of the Contract that consists of written requirements for materials, equipment, systems, standards, and workmanship as applied to the Work, and certain administrative requirements and procedural matters applicable to the Work.
40. *Subcontractor*—An individual or entity having a direct contract with Contractor or with any other Subcontractor for the performance of a part of the Work.
41. *Submittal*—A written or graphic document, prepared by or for Contractor, which the Contract Documents require Contractor to submit to Engineer, or that is indicated as a Submittal in the Schedule of Submittals accepted by Engineer. Submittals may include Shop Drawings and Samples; schedules; product data; Owner-delegated designs; sustainable design information; information on special procedures; testing plans; results of tests and evaluations, source quality-control testing and inspections, and field or Site quality-control testing and inspections; warranties and certifications; Suppliers’ instructions and reports; records of delivery of spare parts and tools; operations and maintenance data; Project photographic documentation; record documents; and other such documents required by the Contract Documents. Submittals, whether or not

approved or accepted by Engineer, are not Contract Documents. Change Proposals, Change Orders, Claims, notices, Applications for Payment, and requests for interpretation or clarification are not Submittals.

42. *Substantial Completion*—The time at which the Work (or a specified part thereof) has progressed to the point where, in the opinion of Engineer, the Work (or a specified part thereof) is sufficiently complete, in accordance with the Contract Documents, so that the Work (or a specified part thereof) can be utilized for the purposes for which it is intended. The terms “substantially complete” and “substantially completed” as applied to all or part of the Work refer to Substantial Completion of such Work. Notwithstanding anything to the contrary herein, “Substantial Completion” shall be considered to be on the date which all applicable governmental agencies having jurisdiction over the Work have issued unconditional certificates of completion and have signed off on all final inspections with respect to each portion of the work and the Owner is able to utilize each portion of the Work set forth in the Contract Documents for the intended purpose. Also notwithstanding anything to the contrary contained herein, Contractor shall be responsible for obtaining the final inspections and applicable written approvals from all governmental agencies with jurisdiction with respect to each portion of the Work, and in connection therewith, Owner and Engineer shall comply with all of its obligations required by the issuing authority in order to enable the Contractor to obtain such Certificate.
43. *Successful Bidder*—The Bidder to which the Owner makes an award of contract.
44. *Supplementary Conditions*—The part of the Contract that amends or supplements these General Conditions.
45. *Supplier*—A manufacturer, fabricator, supplier, distributor, or vendor having a direct contract with Contractor or with any Subcontractor to furnish materials or equipment to be incorporated in the Work by Contractor or a Subcontractor.
46. *Technical Data*
- a. Those items expressly identified as Technical Data in the Supplementary Conditions, with respect to either (1) existing subsurface conditions at or adjacent to the Site, or existing physical conditions at or adjacent to the Site including existing surface or subsurface structures (except Underground Facilities) or (2) Hazardous Environmental Conditions at the Site.
 - b. If no such express identifications of Technical Data have been made with respect to conditions at the Site, then Technical Data is defined, with respect to conditions at the Site under Paragraphs 5.03, 5.04, and 5.06, as the data contained in boring logs, recorded measurements of subsurface water levels, assessments of the condition of subsurface facilities, laboratory test results, and other factual, objective information regarding conditions at the Site that are set forth in any geotechnical, environmental, or other Site or facilities conditions report prepared for the Project and made available to Contractor.
 - c. Information and data regarding the presence or location of Underground Facilities are not intended to be categorized, identified, or defined as Technical Data, and instead Underground Facilities are shown or indicated on the Drawings.

47. *Underground Facilities*—All active or not-in-service underground lines, pipelines, conduits, ducts, encasements, cables, wires, manholes, vaults, tanks, tunnels, or other such facilities or systems at the Site, including but not limited to those facilities or systems that produce, transmit, distribute, or convey telephone or other communications, cable television, fiber optic transmissions, power, electricity, light, heat, gases, oil, crude oil products, liquid petroleum products, water, steam, waste, wastewater, storm water, other liquids or chemicals, or traffic or other control systems. An abandoned facility or system is not an Underground Facility.
48. *Unit Price Work*—Work to be paid for on the basis of unit prices.
49. *Work*—The entire construction or the various separately identifiable parts thereof required to be provided under the Contract Documents. Work includes and is the result of performing or providing all labor, services, and documentation necessary to produce such construction; furnishing, installing, and incorporating all materials and equipment into such construction; and may include related services such as testing, start-up, and commissioning, all as required by the Contract Documents.
50. *Work Change Directive*—A written directive to Contractor issued on or after the Effective Date of the Contract, signed by Owner and recommended by Engineer, ordering an addition, deletion, or revision in the Work.
51. Construction Manager – any individual, entity or firm retained by the Owner to assist the Engineer with the administration of managing, overseeing and processing construction related activities.

1.02 Terminology

- A. The words and terms discussed in Paragraphs 1.02.B, C, D, and E are not defined terms that require initial capital letters, but, when used in the Bidding Requirements or Contract Documents, have the indicated meaning.
- B. *Intent of Certain Terms or Adjectives*: The Contract Documents include the terms “as allowed,” “as approved,” “as ordered,” “as directed” or terms of like effect or import to authorize an exercise of professional judgment by Engineer. In addition, the adjectives “reasonable,” “suitable,” “acceptable,” “proper,” “satisfactory,” or adjectives of like effect or import are used to describe an action or determination of Engineer as to the Work. It is intended that such exercise of professional judgment, action, or determination will be solely to evaluate, in general, the Work for compliance with the information in the Contract Documents and with the design concept of the Project as a functioning whole as shown or indicated in the Contract Documents (unless there is a specific statement indicating otherwise). The use of any such term or adjective is not intended to and shall not be effective to assign to Engineer any duty or authority to supervise or direct the performance of the Work, or any duty or authority to undertake responsibility contrary to the provisions of Article 10 or any other provision of the Contract Documents.
- C. *Day*: The word “day” means a calendar day of 24 hours measured from midnight to the next midnight.
- D. *Defective*: The word “defective,” when modifying the word “Work,” refers to Work that is unsatisfactory, faulty, or deficient in that it:
1. does not conform to the Contract Documents;

2. does not meet the requirements of any applicable inspection, reference standard, test, or approval referred to in the Contract Documents; or
 3. has been damaged prior to Engineer's recommendation of final payment (unless responsibility for the protection thereof has been assumed by Owner at Substantial Completion in accordance with Paragraph 15.03 or Paragraph 15.04).
- E. *Furnish, Install, Perform, Provide*
1. The word "furnish," when used in connection with services, materials, or equipment, means to supply and deliver said services, materials, or equipment to the Site (or some other specified location) ready for use or installation and in usable or operable condition.
 2. The word "install," when used in connection with services, materials, or equipment, means to put into use or place in final position said services, materials, or equipment complete and ready for intended use.
 3. The words "perform" or "provide," when used in connection with services, materials, or equipment, means to furnish and install said services, materials, or equipment complete and ready for intended use.
 4. If the Contract Documents establish an obligation of Contractor with respect to specific services, materials, or equipment, but do not expressly use any of the four words "furnish," "install," "perform," or "provide," then Contractor shall furnish and install said services, materials, or equipment complete and ready for intended use.
- F. *Contract Price or Contract Times*: References to a change in "Contract Price or Contract Times" or "Contract Times or Contract Price" or similar, indicate that such change applies to (1) Contract Price, (2) Contract Times, or (3) both Contract Price and Contract Times, as warranted, even if the term "or both" is not expressed.
- G. Unless stated otherwise in the Contract Documents, words or phrases that have a well-known technical or construction industry or trade meaning are used in the Contract Documents in accordance with such recognized meaning.

ARTICLE 2—PRELIMINARY MATTERS

2.01 Delivery of Performance and Payment Bonds; Evidence of Insurance

- A. *Performance and Payment Bonds*: When Contractor delivers the signed counterparts of the Agreement to Owner, Contractor shall also deliver to Owner the performance bond and payment bond (if the Contract requires Contractor to furnish such bonds). Contractor must provide a certified copy of the recorded bonds before commencing the Work or before recommending the Work after a default or abandonment.
- B. *Evidence of Contractor's Insurance*: When Contractor delivers the signed counterparts of the Agreement to Owner, Contractor shall also deliver to Owner, with copies to each additional insured (as identified in the Contract), the certificates, endorsements, and other evidence of insurance required to be provided by Contractor in accordance with Article 6, except to the extent the Supplementary Conditions expressly establish other dates for delivery of specific insurance policies.
- C. *Evidence of Owner's Insurance*: After receipt of the signed counterparts of the Agreement and all required bonds and insurance documentation, Owner shall promptly deliver to Contractor,

~~with copies to each additional insured (as identified in the Contract), the certificates and other evidence of insurance required to be provided by Owner under Article 6.~~

2.02 Copies of Documents

- A. Owner shall furnish to Contractor four printed copies of the Contract (including one fully signed counterpart of the Agreement), and one copy in electronic portable document format (PDF). Additional printed copies will be furnished upon request at the cost of reproduction.
- B. Owner shall maintain and safeguard at least one original printed record version of the Contract, including Drawings and Specifications signed and sealed by Engineer and other design professionals. Owner shall make such original printed record version of the Contract available to Contractor for review. Owner may delegate the responsibilities under this provision to Engineer.

2.03 Before Starting Construction

- A. *Preliminary Schedules:* Within ~~10~~ 3 days after the Effective Date of the Contract (or as otherwise required by the Contract Documents), Contractor shall submit to Engineer for timely review:
 - 1. a preliminary Progress Schedule indicating the times (numbers of days or dates) for starting and completing the various stages of the Work, including any Milestones specified in the Contract;
 - 2. a preliminary Schedule of Submittals; and
 - 3. a preliminary Schedule of Values for all of the Work which includes quantities and prices of items which when added together equal the Contract Price and subdivides the Work into component parts in sufficient detail to serve as the basis for progress payments during performance of the Work. Such prices will include an appropriate amount of overhead and profit applicable to each item of Work.

Such schedules shall be consistent with the documents provided to the Owner as part of the Contractor's Bid.

2.04 Preconstruction Conference; Designation of Authorized Representatives

- A. Before any Work at the Site is started, a conference attended by Owner, Contractor, Engineer, and others as appropriate will be held to establish a working understanding among the parties as to the Work, and to discuss the schedules referred to in Paragraph 2.03.A, procedures for handling Shop Drawings, Samples, and other Submittals, processing Applications for Payment, electronic or digital transmittals, and maintaining required records.
- B. At this conference Owner and Contractor each shall designate, in writing, a specific individual to act as its authorized representative with respect to the services and responsibilities under the Contract. Such individuals shall have the authority to transmit and receive information, render decisions relative to the Contract, and otherwise act on behalf of each respective party.

2.05 Acceptance of Schedules

- A. At least 10 days before submission of the first Application for Payment a conference, attended by Contractor, Engineer, and others as appropriate, will be held to review the schedules

submitted in accordance with Paragraph 2.03.A. No progress payment will be made to Contractor until acceptable schedules are submitted to Engineer.

1. The Progress Schedule will be acceptable to Engineer if it provides an orderly progression of the Work to completion within the Contract Times. Such acceptance will not impose on Engineer responsibility for the Progress Schedule, for sequencing, scheduling, or progress of the Work, nor interfere with or relieve Contractor from Contractor's full responsibility therefor.
2. Contractor's Schedule of Submittals will be acceptable to Engineer if it provides a workable arrangement for reviewing and processing the required submittals.
3. Contractor's Schedule of Values will be acceptable to Engineer as to form and substance if it provides a reasonable allocation of the Contract Price to the component parts of the Work.
4. If a schedule is not acceptable, Contractor will have an additional 10 days to revise and resubmit the schedule.

Such schedules shall be consistent with the documents provided to the Owner as part of the Contractor's Bid.

2.06 Electronic Transmittals

- A. Except as otherwise stated elsewhere in the Contract, the Owner, Engineer, Construction Manager, and Contractor may send, and shall accept, Electronic Documents transmitted by Electronic Means.
- B. If the Contract does not establish protocols for Electronic Means, then Owner, Engineer, Construction Manager, and Contractor shall jointly develop such protocols.
- C. Subject to any governing protocols for Electronic Means, when transmitting Electronic Documents by Electronic Means, the transmitting party makes no representations as to long-term compatibility, usability, or readability of the Electronic Documents resulting from the recipient's use of software application packages, operating systems, or computer hardware differing from those used in the drafting or transmittal of the Electronic Documents.

ARTICLE 3—CONTRACT DOCUMENTS: INTENT, REQUIREMENTS, REUSE

3.01 Intent

- A. The Contract Documents are complementary; what is required by one Contract Document is as binding as if required by all.
- B. It is the intent of the Contract Documents to describe a functionally complete Project (or part thereof) to be constructed in accordance with the Contract Documents.
- C. Unless otherwise stated in the Contract Documents, if there is a discrepancy between the electronic versions of the Contract Documents (including any printed copies derived from such electronic versions) and the printed record version, the printed record version will govern.
- D. The Contract supersedes prior negotiations, representations, and agreements, whether written or oral.

- E. Engineer will issue clarifications and interpretations of the Contract Documents as provided herein.
- F. Any provision or part of the Contract Documents held to be void or unenforceable under any Law or Regulation will be deemed stricken, and all remaining provisions will continue to be valid and binding upon Owner and Contractor, which agree that the Contract Documents will be reformed to replace such stricken provision or part thereof with a valid and enforceable provision that comes as close as possible to expressing the intention of the stricken provision.
- G. Nothing in the Contract Documents creates:
 - 1. any contractual relationship between Owner or Engineer or Construction Manager and any Subcontractor, Supplier, or other individual or entity performing or furnishing any of the Work, for the benefit of such Subcontractor, Supplier, or other individual or entity; or
 - 2. any obligation on the part of Owner or Engineer or Construction Manager to pay or to see to the payment of any money due any such Subcontractor, Supplier, or other individual or entity, except as may otherwise be required by Laws and Regulations.

3.02 Reference Standards

A. *Standards Specifications, Codes, Laws and Regulations*

- 1. Reference in the Contract Documents to standard specifications, manuals, reference standards, or codes of any technical society, organization, or association, or to Laws or Regulations, whether such reference be specific or by implication, means the standard specification, manual, reference standard, code, or Laws or Regulations in effect at the time of opening of Bids (or on the Effective Date of the Contract if there were no Bids), except as may be otherwise specifically stated in the Contract Documents.
- 2. No provision of any such standard specification, manual, reference standard, or code, and no instruction of a Supplier, will be effective to change the duties or responsibilities of Owner, Contractor, or Engineer from those set forth in the part of the Contract Documents prepared by or for Engineer. No such provision or instruction shall be effective to assign to Owner or Engineer any duty or authority to supervise or direct the performance of the Work, or any duty or authority to undertake responsibility inconsistent with the provisions of the part of the Contract Documents prepared by or for Engineer.

3.03 Reporting and Resolving Discrepancies

A. *Reporting Discrepancies*

- 1. *Contractor's Verification of Figures and Field Measurements:* Before undertaking each part of the Work, Contractor shall carefully study the Contract Documents, and check and verify pertinent figures and dimensions therein, particularly with respect to applicable field measurements. Contractor shall promptly report in writing to Engineer any conflict, error, ambiguity, or discrepancy that Contractor discovers, or has actual knowledge of, and shall not proceed with any Work affected thereby until the conflict, error, ambiguity, or discrepancy is resolved by a clarification or interpretation by Engineer, or by an amendment or supplement to the Contract issued pursuant to Paragraph 11.01.
- 2. *Contractor's Review of Contract Documents:* If, before or during the performance of the Work, Contractor discovers any conflict, error, ambiguity, or discrepancy within the

Contract Documents, or between the Contract Documents and (a) any applicable Law or Regulation, (b) actual field conditions, (c) any standard specification, manual, reference standard, or code, or (d) any instruction of any Supplier, then Contractor shall promptly report it to Engineer in writing. Contractor shall not proceed with the Work affected thereby (except in an emergency as required by Paragraph 7.15) until the conflict, error, ambiguity, or discrepancy is resolved, by a clarification or interpretation by Engineer, or by an amendment or supplement to the Contract issued pursuant to Paragraph 11.01.

3. ~~Contractor shall not be liable to Owner or Engineer for failure to report any conflict, error, ambiguity, or discrepancy in the Contract Documents unless Contractor had actual knowledge thereof.~~

B. *Resolving Discrepancies*

1. Except as may be otherwise specifically stated in the Contract Documents, the provisions of the part of the Contract Documents prepared by or for Engineer take precedence in resolving any conflict, error, ambiguity, or discrepancy between such provisions of the Contract Documents and:
 - a. the provisions of any standard specification, manual, reference standard, or code, or the instruction of any Supplier (whether or not specifically incorporated by reference as a Contract Document); or
 - b. the provisions of any Laws or Regulations applicable to the performance of the Work (unless such an interpretation of the provisions of the Contract Documents would result in violation of such Law or Regulation).

3.04 Requirements of the Contract Documents

- A. During the performance of the Work and until final payment, Contractor and Owner shall submit to the Engineer in writing all matters in question concerning the requirements of the Contract Documents (sometimes referred to as requests for information or interpretation—RFIs), or relating to the acceptability of the Work under the Contract Documents, as soon as possible after such matters arise. Engineer will be the initial interpreter of the requirements of the Contract Documents, and judge of the acceptability of the Work.
- B. Engineer will, with reasonable promptness, render a written clarification, interpretation, or decision on the issue submitted, or initiate an amendment or supplement to the Contract Documents. Engineer's written clarification, interpretation, or decision will be final and binding on Contractor, unless it appeals by submitting a Change Proposal, and on Owner, unless it appeals by filing a Claim.
- C. If a submitted matter in question concerns terms and conditions of the Contract Documents that do not involve (1) the performance or acceptability of the Work under the Contract Documents, (2) the design (as set forth in the Drawings, Specifications, or otherwise), or (3) other engineering or technical matters, then Engineer will promptly notify Owner and Contractor in writing that Engineer is unable to provide a decision or interpretation. If Owner and Contractor are unable to agree on resolution of such a matter in question, either party may pursue resolution as provided in Article 12.

3.05 Reuse of Documents

- A. Contractor and its Subcontractors and Suppliers shall not:
 - 1. have or acquire any title to or ownership rights in any of the Drawings, Specifications, or other documents (or copies of any thereof) prepared by or bearing the seal of Engineer or its consultants, including electronic media versions, or reuse any such Drawings, Specifications, other documents, or copies thereof on extensions of the Project or any other project without written consent of Owner and Engineer and specific written verification or adaptation by Engineer; or
 - 2. have or acquire any title or ownership rights in any other Contract Documents, reuse any such Contract Documents for any purpose without Owner's express written consent, or violate any copyrights pertaining to such Contract Documents.
- B. The prohibitions of this Paragraph 3.05 will survive final payment, or termination of the Contract. Nothing herein precludes Contractor from retaining copies of the Contract Documents for record purposes.

ARTICLE 4—COMMENCEMENT AND PROGRESS OF THE WORK

4.01 Commencement of Contract Times; Notice to Proceed

- A. The Contract Times will commence to run ~~on the 30th day after the Effective Date of the Contract or, if a Notice to Proceed is given, on the day indicated in the Notice to Proceed. A Notice to Proceed may be given at any time within 30 days after the Effective Date of the Contract. No Work shall be performed before the issuance of a Notice to Proceed. In no event will the Contract Times commence to run later than the 60th day after the day of Bid opening or the 30th day after the Effective Date of the Contract, whichever date is earlier.~~

4.02 Starting the Work

- A. Contractor shall start to perform the Work on the date when the Contract Times commence to run. No Work may be done at the Site prior to such date.

4.03 Reference Points

- A. Owner shall provide engineering surveys to establish reference points for construction which in Engineer's judgment are necessary to enable Contractor to proceed with the Work. Contractor shall be responsible for laying out the Work, shall protect and preserve the established reference points and property monuments, and shall make no changes or relocations without the prior written approval of Owner. Contractor shall report to Engineer whenever any reference point or property monument is lost or destroyed or requires relocation because of necessary changes in grades or locations, and shall be responsible for the accurate replacement or relocation of such reference points or property monuments by professionally qualified personnel.

4.04 Progress Schedule

- A. Contractor shall adhere to the Progress Schedule established in accordance with Paragraph 2.05 as it may be adjusted from time to time as provided below.

1. Contractor shall submit to Engineer for acceptance (to the extent indicated in Paragraph 2.05) proposed adjustments in the Progress Schedule that will not result in changing the Contract Times.
 2. Proposed adjustments in the Progress Schedule that will change the Contract Times must be submitted in accordance with the requirements of Article 11.
- B. Contractor shall carry on the Work and adhere to the Progress Schedule during all disputes or disagreements with Owner. No Work will be delayed or postponed pending resolution of any disputes or disagreements, or during any appeal process, except as permitted by Paragraph 16.04, or as Owner and Contractor may otherwise agree in writing.

4.05 Delays in Contractor's Progress

- A. If Owner, Engineer, or anyone for whom Owner is responsible, delays, disrupts, or interferes with the performance or progress of the Work, then Contractor shall be entitled to an equitable adjustment in Contract Price or Contract Times.
- B. Contractor shall not be entitled to an adjustment in Contract Price or Contract Times for delay, disruption, or interference caused by or within the control of Contractor. Delay, disruption, and interference attributable to and within the control of a Subcontractor or Supplier shall be deemed to be within the control of Contractor.
- C. If Contractor's performance or progress is delayed, disrupted, or interfered with by unanticipated causes not the fault of and beyond the control of Owner, Contractor, and those for which they are responsible, then Contractor shall be entitled to an equitable adjustment in Contract Times. Such an adjustment will be Contractor's sole and exclusive remedy for the delays, disruption, and interference described in this paragraph. Causes of delay, disruption, or interference that may give rise to an adjustment in Contract Times under this paragraph include ~~but are not limited to~~ only the following:
1. Severe and unavoidable acts of God or natural catastrophes such as fires, floods, epidemics, and earthquakes;
 2. Abnormal weather conditions;
 3. Acts or failures to act of third-party utility owners or other third-party entities (other than those third-party utility owners or other third-party entities performing other work at or adjacent to the Site as arranged by or under contract with Owner, as contemplated in Article 8); and
 4. Acts of war or terrorism.

Contractor must submit any Change Proposal seeking an equitable adjustment in the Contract Times under this paragraph within 15 days of the damaging, delaying, disrupting, or interfering event, or such claim shall be waived. Contractor shall be required to prove that any abnormal weather conditions are in excess of normal rainfall amounts or other normal weather conditions, and must provide such documentation of unusually severe weather as the Engineer deems reasonably necessary. Normal seasonal adverse weather typical for the area, including heavy rain shall not be deemed as causing any delays for the Project.

In no event shall Owner or Engineer be liable to Contractor, any subcontractor, any supplier, or any other person or organization, or to any surety or employee or any agent of them, for damages, including but not limited to all fees and charges of Engineers, architects, attorneys,

and other professionals and all court or arbitration or other dispute resolution costs, arising out of or resulting from:

1. delays caused by or within the control of Contractor (or Subcontractor or Supplier); or
2. delays beyond the control of both Owner and Contractor, including, but not limited to, fires, floods, epidemics, abnormal weather conditions, acts of God, or acts or neglect by utility owners or other contractors performing other work;

Nor shall Owner or Engineer of each of them be liable to Contractor for any claims, costs, losses or damages sustained by Contractor on or in connection with any other project or anticipated project.

Except for an adjustment to the Contract Times, the Contractor shall not be entitled to and hereby waives any and all damages that it may suffer by reason of delay or for any Act of God, and waives all damages that it may suffer by reason of such delay including but not limited to lost profits, overhead, and other consequential damages. No payment of any claim for damages shall be made to the Contractor as compensation for damages for any delays or hindrances that are avoidable by Contractor.

- D. Contractor's entitlement to an adjustment of Contract Times or Contract Price is limited and conditioned as follows:
1. Contractor's entitlement to an adjustment of the Contract Times is conditioned on the delay, disruption, or interference adversely affecting an activity on the critical path to completion of the Work, as of the time of the delay, disruption, or interference.
 2. Contractor shall not be entitled to an adjustment in Contract Price for any delay, disruption, or interference if such delay is concurrent with a delay, disruption, or interference caused by or within the control of Contractor. Such a concurrent delay by Contractor shall not preclude an adjustment of Contract Times to which Contractor is otherwise entitled.
 3. Adjustments of Contract Times or Contract Price are subject to the provisions of Article 11.
 4. The District, in its sole and absolute discretion, may additionally direct that the Project be delivered in multiple phases rather than all at once. Such option, if exercised, shall in no way impact the pricing of the Project, nor constitute a delay.
- E. Each Contractor request or Change Proposal seeking an increase in Contract Times or Contract Price must be supplemented by supporting data that sets forth in detail the following:
1. The circumstances that form the basis for the requested adjustment;
 2. The date upon which each cause of delay, disruption, or interference began to affect the progress of the Work;
 3. The date upon which each cause of delay, disruption, or interference ceased to affect the progress of the Work;
 4. The number of days' increase in Contract Times claimed as a consequence of each such cause of delay, disruption, or interference; and
 5. The impact on Contract Price, in accordance with the provisions of Paragraph 11.07.

Contractor shall also furnish such additional supporting documentation as Owner or Engineer may require including, where appropriate, a revised progress schedule indicating all the activities affected by the delay, disruption, or interference, and an explanation of the effect of the delay, disruption, or interference on the critical path to completion of the Work. Such supporting documentation shall include, where appropriate, documentation of abnormal weather conditions and an explanation of their impact on Contract Price and/or Contract Times.

- F. Delays, disruption, and interference to the performance or progress of the Work resulting from the existence of a differing subsurface or physical condition, an Underground Facility that was not shown or indicated by the Contract Documents, or not shown or indicated with reasonable accuracy, and those resulting from Hazardous Environmental Conditions, are governed by Article 5, together with the provisions of Paragraphs 4.05.D and 4.05.E.
- G. Paragraph 8.03 addresses delays, disruption, and interference to the performance or progress of the Work resulting from the performance of certain other work at or adjacent to the Site.

ARTICLE 5—SITE; SUBSURFACE AND PHYSICAL CONDITIONS; HAZARDOUS ENVIRONMENTAL CONDITIONS

5.01 Availability of Lands

- A. Owner shall furnish the Site. Owner shall notify Contractor in writing of any encumbrances or restrictions not of general application but specifically related to use of the Site with which Contractor must comply in performing the Work.
- B. ~~Upon reasonable written request, Owner shall furnish Contractor with a current statement of record legal title and legal description of the lands upon which permanent improvements are to be made and Owner's interest therein as necessary for giving notice of or filing a mechanic's or construction lien against such lands in accordance with applicable Laws and Regulations.~~
- C. Contractor shall provide for all additional lands and access thereto that may be required for temporary construction facilities or storage of materials and equipment.

5.02 Use of Site and Other Areas

A. *Limitation on Use of Site and Other Areas*

- 1. Contractor shall confine construction equipment, temporary construction facilities, the storage of materials and equipment, and the operations of workers to the Site, adjacent areas that Contractor has arranged to use through construction easements or otherwise, and other adjacent areas permitted by Laws and Regulations, and shall not unreasonably encumber the Site and such other adjacent areas with construction equipment or other materials or equipment. Contractor shall assume full responsibility for (a) damage to the Site; (b) damage to any such other adjacent areas used for Contractor's operations; (c) damage to any other adjacent land or areas, or to improvements, structures, utilities, or similar facilities located at such adjacent lands or areas; and (d) for injuries and losses sustained by the owners or occupants of any such land or areas; provided that such damage or injuries result from the performance of the Work or from other actions or conduct of the Contractor or those for which Contractor is responsible.
- 2. If a damage or injury claim is made by the owner or occupant of any such land or area because of the performance of the Work, or because of other actions or conduct of the

Contractor or those for which Contractor is responsible, Contractor shall (a) take immediate corrective or remedial action as required by Paragraph 7.13, or otherwise; (b) promptly attempt to settle the claim as to all parties through negotiations with such owner or occupant, or otherwise resolve the claim by arbitration or other dispute resolution proceeding, or in a court of competent jurisdiction; and (c) to the fullest extent permitted by Laws and Regulations, indemnify, defend and hold harmless Indemnitees (defined in Paragraph 7.18) ~~Owner and Engineer, and the officers, directors, members, partners, employees, agents, consultants and subcontractors of each and any of them,~~ from and against any such claim, and against all liabilities, suits, liens, demands, costs, losses, interest, expenses, penalties, fines, judgments, and damages (including but not limited to all fees and charges of engineers, architects, attorneys, and other professionals and all court or arbitration or other dispute resolution fees and costs) whether monetary or otherwise, arising, in whole or in part, out of or relating to any claim or action, legal or equitable, brought by any such owner or occupant against Owner, Engineer, or any other party indemnified hereunder to the extent caused directly or indirectly, in whole or in part by, or based upon, Contractor's negligent, reckless or intentionally wrongful performance of the Work, or because of other negligent, reckless or intentionally wrongful actions or conduct of the Contractor or those for which Contractor is responsible.

- B. *Removal of Debris During Performance of the Work:* During the progress of the Work the Contractor shall keep the Site and other adjacent areas free from accumulations of waste materials, rubbish, and other debris. Removal and disposal of such waste materials, rubbish, and other debris will conform to applicable Laws and Regulations.
- C. *Cleaning:* Prior to Substantial Completion of the Work Contractor shall clean the Site and the Work and make it ready for utilization by Owner. At the completion of the Work Contractor shall remove from the Site and adjacent areas all tools, appliances, construction equipment and machinery, rubbish, debris, and surplus materials and shall restore to original condition all property not designated for alteration by the Contract Documents.
- D. *Loading of Structures:* Contractor shall not load nor permit any part of any structure to be loaded in any manner that will endanger the structure, nor shall Contractor subject any part of the Work or adjacent structures or land to stresses or pressures that will endanger them.

5.03 Subsurface and Physical Conditions

- A. *Reports and Drawings:* The Supplementary Conditions identify:
 - 1. Those reports known to Owner of explorations and tests of subsurface conditions at or adjacent to the Site ~~that contain Technical Data~~ from which the Engineer prepared the Contract Drawings and Specifications;
 - 2. Those drawings of existing physical conditions at or adjacent to the Site, including those drawings depicting existing surface or subsurface structures at or adjacent to the Site (except Underground Facilities), ~~that contain Technical Data~~ from which the Engineer prepared the Contract Drawings and Specifications; and
 - 3. Technical Data contained in such reports and drawings, if any.
- B. *Underground Facilities:* Underground Facilities are shown or indicated on the Drawings, pursuant to Paragraph 5.05, and not in the drawings referred to in Paragraph 5.03.A.

Information and data regarding the presence or location of Underground Facilities are not intended to be categorized, identified, or defined as Technical Data.

- C. No Reliance by Contractor on Technical Data: Contractor may not rely upon the accuracy of the Technical Data expressly identified in the Supplementary Conditions with respect to such reports and drawings, ~~but such reports and drawings are not Contract Documents. If no such express identification has been made, then Contractor may rely upon the accuracy of the Technical Data as defined in Paragraph 1.01.A.46.b.~~ Instead, while the Technical Data is believed to be reliable, the Technical Data was prepared for Owner's benefit by third parties and accordingly, Owner cannot guarantee the quantity, quality, completeness or accuracy of that information.
- D. Limitations of Other Data and Documents: ~~Except for such reliance on Technical Data,~~ Contractor may not rely upon or make any claim against Owner or Engineer, or any of their officers, directors, members, partners, employees, agents, consultants, or subcontractors, with respect to:
1. the completeness of such reports and drawings for Contractor's purposes, including, but not limited to, any aspects of the means, methods, techniques, sequences, and procedures of construction to be employed by Contractor, and safety precautions and programs incident thereto;
 2. other data, interpretations, opinions, and information contained in such reports or shown or indicated in such drawings;
 3. the contents of other Site-related documents made available to Contractor, such as record drawings from other projects at or adjacent to the Site, or Owner's archival documents concerning the Site; or
 4. any Contractor interpretation of or conclusion drawn from any Technical Data or any such other data, interpretations, opinions, or information.
 5. Contractor expressly acknowledges that soil conditions may vary widely across the Site, and Contractor takes responsibility for any and all issues arising from unsuitable soils, including but not limited to, varying soil conditions, etc. that may make it more difficult to install the repairs or otherwise conduct the Work. Furthermore, no additional costs will be charged by Contractor for matters associated with unsuitable and/or varying soils, except that the Contractor may apply for a change order where authorized by the District Engineer and with respect to "templating."
 6. Contractor warrants it has, by careful examination, satisfied itself as to the nature and location of the Work, the conformation of the ground, the character, quality and quantity of the materials to be encountered, the character of equipment and facilities needed preliminary to and during the prosecuting of the Work. Contractor further warrants that the Contract Price is just and reasonable compensation for all the Work, including all foreseen and unforeseen risks, hazards, and difficulties in connection therewith, including any concealed conditions encountered in the performance of the Work below the surface of the ground at variance with conditions indicated by the Contract Documents or other Bidding Documents and Bidding Requirements furnished to the Contractor for its information.

5.04 Differing Subsurface or Physical Conditions

- A. *Notice by Contractor:* If Contractor believes that any subsurface or physical condition that is uncovered or revealed at the Site:
1. is of such a nature as to establish that any Technical Data ~~on which Contractor is entitled to rely as provided in Paragraph 5.03~~ is materially inaccurate;
 2. is of such a nature as to require a change in the Drawings or Specifications;
 3. differs materially from that shown or indicated in the Contract Documents; or
 4. is of an unusual nature, and differs materially from conditions ordinarily encountered and generally recognized as inherent in work of the character provided for in the Contract Documents;

then Contractor shall, promptly after becoming aware thereof and before further disturbing the subsurface or physical conditions or performing any Work in connection therewith (except in an emergency as required by Paragraph 7.15), notify Owner and Engineer in writing about such condition. Contractor shall not further disturb such condition or perform any Work in connection therewith (except with respect to an emergency) until receipt of a written statement permitting Contractor to do so.

- B. *Engineer's Review:* After receipt of written notice as required by the preceding paragraph, Engineer will promptly review the subsurface or physical condition in question; determine whether it is necessary for Owner to obtain additional exploration or tests with respect to the condition; conclude whether the condition falls within any one or more of the differing site condition categories in Paragraph 5.04.A; obtain any pertinent cost or schedule information from Contractor; prepare recommendations to Owner regarding the Contractor's resumption of Work in connection with the subsurface or physical condition in question and the need for any change in the Drawings or Specifications; and advise Owner in writing of Engineer's findings, conclusions, and recommendations.
- C. *Owner's Statement to Contractor Regarding Site Condition:* After receipt of Engineer's written findings, conclusions, and recommendations, Owner shall issue a written statement to Contractor (with a copy to Engineer) regarding the subsurface or physical condition in question, addressing the resumption of Work in connection with such condition, indicating whether any change in the Drawings or Specifications will be made, and adopting or rejecting Engineer's written findings, conclusions, and recommendations, in whole or in part.
- D. *Early Resumption of Work:* If at any time Engineer determines that Work in connection with the subsurface or physical condition in question may resume prior to completion of Engineer's review or Owner's issuance of its statement to Contractor, because the condition in question has been adequately documented, and analyzed on a preliminary basis, then the Engineer may at its discretion instruct Contractor to resume such Work.
- E. *Possible Price and Times Adjustments*
1. Contractor shall be entitled to an equitable adjustment in Contract Price or Contract Times, to the extent that the existence of a differing subsurface or physical condition, or any related delay, disruption, or interference, causes an increase or decrease in

Contractor's cost of, or time required for, performance of the Work; subject, however, to the following:

- a. Such condition must fall within any one or more of the categories described in Paragraph 5.04.A;
 - b. With respect to Work that is paid for on a unit price basis, any adjustment in Contract Price will be subject to the provisions of Paragraph 13.03; and,
 - c. Contractor's entitlement to an adjustment of the Contract Times is subject to the provisions of Paragraphs 4.05.D and 4.05.E.
2. Contractor shall not be entitled to any adjustment in the Contract Price or Contract Times with respect to a subsurface or physical condition if:
- a. Contractor knew of the existence of such condition at the time Contractor made a commitment to Owner with respect to Contract Price and Contract Times by the submission of a Bid or becoming bound under a negotiated contract, or otherwise;
 - b. The existence of such condition reasonably could have been discovered or revealed as a result of any examination, investigation, exploration, test, or study of the Site and contiguous areas expressly required by the Bidding Requirements or Contract Documents to be conducted by or for Contractor prior to Contractor's making such commitment; or
 - c. Contractor failed to give the written notice required by Paragraph 5.04.A.
3. If Owner and Contractor agree regarding Contractor's entitlement to and the amount or extent of any adjustment in the Contract Price or Contract Times, then any such adjustment will be set forth in a Change Order.
4. Contractor may submit a Change Proposal regarding its entitlement to or the amount or extent of any adjustment in the Contract Price or Contract Times, no later than 30 days after Owner's issuance of the Owner's written statement to Contractor regarding the subsurface or physical condition in question.
- F. *Underground Facilities; Hazardous Environmental Conditions:* Paragraph 5.05 governs rights and responsibilities regarding the presence or location of Underground Facilities. Paragraph 5.06 governs rights and responsibilities regarding Hazardous Environmental Conditions. The provisions of Paragraphs 5.03 and 5.04 are not applicable to the presence or location of Underground Facilities, or to Hazardous Environmental Conditions.

5.05 Underground Facilities

- A. *Contractor's Responsibilities:* Owner and Engineer do not warrant or guarantee the accuracy or completeness of any information or data regarding underground facilities provided by others. Unless it is otherwise expressly provided in the Supplementary Conditions, the cost of all of the following are included in the Contract Price, and Contractor shall have full responsibility for, without additional compensation from the Owner:
1. reviewing and checking all information and data regarding existing Underground Facilities at the Site;
 2. complying with applicable state and local utility damage prevention Laws and Regulations, including but not limited to notification of and cooperation with utility

companies and agencies when the Contractor's operations are close to existing facilities in order to provide time for the utilities to stake the location of their existing facilities. This coordination effort shall be done in compliance with Florida Statutes Chapter 556, "Underground Facility Damage Prevention and Safety Act," latest revision.;

3. locating or verifying the actual location of those Underground Facilities shown or indicated in the Contract Documents as being within the area affected by the Work, by exposing such Underground Facilities during the course of construction;
 4. coordination of the Work with the owners (including Owner) of such Underground Facilities, during construction; and
 5. the safety and protection of all existing Underground Facilities at the Site, and repairing any damage thereto resulting from the Work.
- B. *Notice by Contractor:* If Contractor believes that an Underground Facility that is uncovered or revealed at the Site was not shown or indicated on the Drawings, or was not shown or indicated on the Drawings with reasonable accuracy, then Contractor shall, promptly after becoming aware thereof and before further disturbing conditions affected thereby or performing any Work in connection therewith (except in an emergency as required by Paragraph 7.15), notify Owner and Engineer in writing regarding such Underground Facility.
- C. *Engineer's Review:* Engineer will:
1. promptly review the Underground Facility and conclude whether such Underground Facility was not shown or indicated on the Drawings, or was not shown or indicated with reasonable accuracy;
 2. identify and communicate with the owner of the Underground Facility; prepare recommendations to Owner (and if necessary issue any preliminary instructions to Contractor) regarding the Contractor's resumption of Work in connection with the Underground Facility in question;
 3. obtain any pertinent cost or schedule information from Contractor; determine the extent, if any, to which a change is required in the Drawings or Specifications to reflect and document the consequences of the existence or location of the Underground Facility; and
 4. advise Owner in writing of Engineer's findings, conclusions, and recommendations.
- During such time, Contractor shall be responsible for the safety and protection of such Underground Facility.
- D. *Owner's Statement to Contractor Regarding Underground Facility:* After receipt of Engineer's written findings, conclusions, and recommendations, Owner shall issue a written statement to Contractor (with a copy to Engineer) regarding the Underground Facility in question addressing the resumption of Work in connection with such Underground Facility, indicating whether any change in the Drawings or Specifications will be made, and adopting or rejecting Engineer's written findings, conclusions, and recommendations in whole or in part.
- E. *Early Resumption of Work:* If at any time Engineer determines that Work in connection with the Underground Facility may resume prior to completion of Engineer's review or Owner's issuance of its statement to Contractor, because the Underground Facility in question and conditions affected by its presence have been adequately documented, and analyzed on a

preliminary basis, then the Engineer may at its discretion instruct Contractor to resume such Work.

F. *Possible Price and Times Adjustments*

1. Contractor shall be entitled to an equitable adjustment in the Contract Price or Contract Times, to the extent that any existing Underground Facility at the Site that was not shown or indicated on the Drawings, or was not shown or indicated with reasonable accuracy, or any related delay, disruption, or interference, causes an increase or decrease in Contractor's cost of, or time required for, performance of the Work; subject, however, to the following:
 - a. With respect to Work that is paid for on a unit price basis, any adjustment in Contract Price will be subject to the provisions of Paragraph 13.03;
 - b. Contractor's entitlement to an adjustment of the Contract Times is subject to the provisions of Paragraphs 4.05.D and 4.05.E; and
 - c. Contractor gave the notice required in Paragraph 5.05.B.
2. If Owner and Contractor agree regarding Contractor's entitlement to and the amount or extent of any adjustment in the Contract Price or Contract Times, then any such adjustment will be set forth in a Change Order.
3. Contractor may submit a Change Proposal regarding its entitlement to or the amount or extent of any adjustment in the Contract Price or Contract Times, no later than 30 days after Owner's issuance of the Owner's written statement to Contractor regarding the Underground Facility in question.
4. The information and data shown or indicated on the Drawings with respect to existing Underground Facilities at the Site is based on information and data (a) furnished by the owners of such Underground Facilities, or by others, (b) obtained from available records, or (c) gathered in an investigation conducted in accordance with the current edition of ASCE 38, Standard Guideline for the Collection and Depiction of Existing Subsurface Utility Data, by the American Society of Civil Engineers. If such information or data is incorrect or incomplete, Contractor's remedies are limited to those set forth in this Paragraph 5.05.F.

5.06 Hazardous Environmental Conditions at Site

A. *Reports and Drawings:* The Supplementary Conditions identify:

1. ~~those reports known to Owner relating to Hazardous Environmental Conditions that have been identified at or adjacent to the Site, if any;~~
2. ~~drawings known to Owner relating to Hazardous Environmental Conditions that have been identified at or adjacent to the Site, if any; and~~
3. ~~Technical Data contained in such reports and drawings.~~

B. ~~*No Reliance by Contractor on Technical Data Authorized:* Contractor may not rely upon the accuracy of the Technical Data expressly identified in the Supplementary Conditions with respect to such reports and drawings. but such reports and drawings are not Contract Documents. If no such express identification has been made, then Contractor may rely on the accuracy of the Technical Data as defined in Paragraph 1.01.A.46.b. Instead, while the~~

- ~~Technical Data is believed to be reliable, the Technical Data was prepared for the Owner's benefit by third parties and accordingly, the Owner cannot guarantee the quantity, quality, completeness or accuracy of that information. Except for such reliance on Technical Data, Contractor may not rely upon or make any claim against Owner or Engineer, or any of their officers, directors, members, partners, employees, agents, consultants, or subcontractors, with respect to:~~
- ~~1. the completeness of such reports and drawings for Contractor's purposes, including, but not limited to, any aspects of the means, methods, techniques, sequences and procedures of construction to be employed by Contractor, and safety precautions and programs incident thereto;~~
 - ~~2. other data, interpretations, opinions, and information contained in such reports or shown or indicated in such drawings; or~~
 - ~~3. any Contractor interpretation of or conclusion drawn from any Technical Data or any such other data, interpretations, opinions or information.~~
- C. Contractor shall not be responsible for removing or remediating any Hazardous Environmental Condition encountered, uncovered, or revealed at the Site unless such removal or remediation is expressly identified in the Contract Documents to be within the scope of the Work.
- D. Contractor shall be responsible for controlling, containing, and duly removing all Constituents of Concern brought to the Site by Contractor, Subcontractors, Suppliers, or anyone else for whom Contractor is responsible, and for any associated costs; and for the costs of removing and remediating any Hazardous Environmental Condition created by the presence of any such Constituents of Concern. Neither Contractor nor any of its successors, assigns, agents, employees, contractors, subcontractors, materialmen, officers, invitees, and representatives shall store, place, generate, manufacture, refine, handle, or locate on the Site a Constituent of Concern.
- E. If Contractor encounters, uncovers, or reveals a Hazardous Environmental Condition whose removal or remediation is not expressly identified in the Contract Documents as being within the scope of the Work, or if Contractor or anyone for whom Contractor is responsible creates a Hazardous Environmental Condition, then Contractor shall immediately: (1) secure or otherwise isolate such condition; (2) stop all Work in connection with such condition and in any area affected thereby (except in an emergency as required by Paragraph 7.15); and (3) notify Owner and Engineer (and promptly thereafter confirm such notice in writing). Owner shall promptly consult with Engineer concerning the necessity for Owner to retain a qualified expert to evaluate such condition or take corrective action, if any. Promptly after consulting with Engineer, Owner shall take such actions as are necessary to permit Owner to timely obtain required permits and provide Contractor the written notice required by Paragraph 5.06.F. If Contractor or anyone for whom Contractor is responsible created the Hazardous Environmental Condition in question, then Owner may remove and remediate the Hazardous Environmental Condition, and impose a set-off against payments to account for the associated costs.
- F. Contractor shall not resume Work in connection with such Hazardous Environmental Condition or in any affected area until after Owner has obtained any required permits related thereto, and delivered written notice to Contractor either (1) specifying that such condition

and any affected area is or has been rendered safe for the resumption of Work, or (2) specifying any special conditions under which such Work may be resumed safely.

- G. If Owner and Contractor cannot agree as to entitlement to or on the amount or extent, if any, of any adjustment in Contract Price or Contract Times, as a result of such Work stoppage, such special conditions under which Work is agreed to be resumed by Contractor, or any costs or expenses incurred in response to the Hazardous Environmental Condition, then within 30 days of Owner's written notice regarding the resumption of Work, Contractor may submit a Change Proposal, or Owner may impose a set-off. Entitlement to any such adjustment is subject to the provisions of Paragraphs 4.05.D, 4.05.E, 11.07, and 11.08.
- H. If, after receipt of such written notice, Contractor does not agree to resume such Work based on a reasonable belief it is unsafe, or does not agree to resume such Work under such special conditions, then Owner may order the portion of the Work that is in the area affected by such condition to be deleted from the Work, following the contractual change procedures in Article 11. Owner may have such deleted portion of the Work performed by Owner's own forces or others in accordance with Article 8.
- I. ~~To the fullest extent permitted by Laws and Regulations, Owner shall indemnify and hold harmless Contractor, Subcontractors, and Engineer, and the officers, directors, members, partners, employees, agents, consultants, and subcontractors of each and any of them, from and against all claims, costs, losses, and damages (including but not limited to all fees and charges of engineers, architects, attorneys, and other professionals, and all court, arbitration, or other dispute resolution costs) arising out of or relating to a Hazardous Environmental Condition, provided that such Hazardous Environmental Condition (1) was not shown or indicated in the Drawings, Specifications, or other Contract Documents, identified as Technical Data entitled to limited reliance pursuant to Paragraph 5.06.B, or identified in the Contract Documents to be included within the scope of the Work, and (2) was not created by Contractor or by anyone for whom Contractor is responsible. Nothing in this Paragraph 5.06.I obligates Owner to indemnify any individual or entity from and against the consequences of that individual's or entity's own negligence.~~
- J. To the fullest extent permitted by Laws and Regulations, Contractor shall indemnify, defend and hold harmless Indemnitees ~~Owner and Engineer, and the officers, directors, members, partners, employees, agents, consultants, and subcontractors of each and any of them,~~ from and against all claims, liabilities, suits, liens, demands, costs, losses, interest, expenses, penalties, fines, judgments, and damages (including but not limited to all fees and charges of engineers, architects, attorneys, and other professionals and all court or arbitration or other dispute resolution fees and costs) arising out of or relating to the wholly or partially negligent, reckless, or intentionally wrongful failure to control, contain, or remove a Constituent of Concern brought to the Site by Contractor or by anyone for whom Contractor is responsible, including without limitation, Contractor's successors, assigns, agents, employees, contractors, subcontractors, materialmen, officers, invitees, and representatives, or to a Hazardous Environmental Condition created in whole or in part by Contractor or by anyone for whom Contractor is responsible. Nothing in this Paragraph 5.06.J obligates Contractor to indemnify any individual or entity from and against the consequences of that individual's or entity's own negligence.
- K. The provisions of Paragraphs 5.03, 5.04, and 5.05 do not apply to the presence of Constituents of Concern or to a Hazardous Environmental Condition uncovered or revealed at the Site.

ARTICLE 6—BONDS AND INSURANCE

6.01 Performance, Payment, and Other Bonds

- A. Contractor shall furnish a performance bond and a payment bond, each in an amount at least equal to the Contract Price, as security for the faithful performance and payment of Contractor's obligations under the Contract. These bonds must remain in effect until one year (for the payment bond) and two years (for the performance bond) after the date when final payment becomes due or until completion of the correction period specified in Paragraph 15.08, whichever is later, except as provided otherwise by Laws or Regulations, the terms of a prescribed bond form, the Supplementary Conditions, or other provisions of the Contract.
- B. Contractor shall also furnish such other bonds (if any) as are required by the Supplementary Conditions or other provisions of the Contract.
- C. All bonds must be in the form included in the Bidding Documents or otherwise specified by Owner prior to execution of the Contract, except as provided otherwise by Laws or Regulations, and must be issued and signed by a surety named in "Companies Holding Certificates of Authority as Acceptable Sureties on Federal Bonds and as Acceptable Reinsuring Companies" as published in Department Circular 570 (as amended and supplemented) by the Bureau of the Fiscal Service, U.S. Department of the Treasury. A bond signed by an agent or attorney-in-fact must be accompanied by a certified copy of that individual's authority to bind the surety. The evidence of authority must show that it is effective on the date the agent or attorney-in-fact signed the accompanying bond. In addition, each bond shall be on an Owner-approved form and the payment bond shall contain the following language: "This Bond is hereby amended so that the provisions and limitations of Section 255.05, including without limitation subsection (6) and the notice and time limitation provisions in subsections (2) and (10), or Sections 713.23 and 713.245, Florida Statutes, whichever are applicable, are incorporated by reference herein."
- D. Contractor shall obtain the required bonds from surety companies that are duly licensed or authorized, in the state or jurisdiction in which the Project is located, to issue bonds in the required amounts.
- E. If the surety on a bond furnished by Contractor is declared bankrupt or becomes insolvent, or the surety ceases to meet the requirements above, then Contractor shall promptly notify Owner and Engineer in writing and shall, within 20 days after the event giving rise to such notification, provide another bond and surety, both of which must comply with the bond and surety requirements above.
- F. If Contractor has failed to obtain a required bond, Owner may exclude the Contractor from the Site and exercise Owner's termination rights under Article 16.
- G. Upon request to Owner from any Subcontractor, Supplier, or other person or entity claiming to have furnished labor, services, materials, or equipment used in the performance of the Work, Owner shall provide a copy of the payment bond to such person or entity.
- H. Upon request to Contractor from any Subcontractor, Supplier, or other person or entity claiming to have furnished labor, services, materials, or equipment used in the performance of the Work, Contractor shall provide a copy of the payment bond to such person or entity.

6.02 Insurance—General Provisions

- A. Owner and Contractor shall obtain and maintain insurance as required in this article and in the Supplementary Conditions.
- B. All insurance required by the Contract to be purchased and maintained by Owner or Contractor shall be obtained from insurance companies that are duly licensed or authorized in the state or jurisdiction in which the Project is located to issue insurance policies for the required limits and coverages. Unless a different standard is indicated in the Supplementary Conditions, all companies that provide insurance policies required under this Contract shall have an A.M. Best rating of A-VII or better.
- C. Alternative forms of insurance coverage, including but not limited to self-insurance and “Occupational Accident and Excess Employer’s Indemnity Policies,” are not sufficient to meet the insurance requirements of this Contract, unless expressly allowed in the Supplementary Conditions.
- D. Prior to commencing the Work and entering any lands upon which the Work shall be performed, Contractor shall deliver to Owner, with copies to each additional insured identified in the Contract, certificates of insurance and endorsements establishing that Contractor has obtained and is maintaining the policies and coverages required by the Contract. Upon request by Owner or any other insured, Contractor shall also furnish other evidence of such required insurance, including but not limited to copies of policies, documentation of applicable self-insured retentions (if allowed) and deductibles, full disclosure of all relevant exclusions, and evidence of insurance required to be purchased and maintained by Subcontractors or Suppliers. In any documentation furnished under this provision, Contractor, Subcontractors, and Suppliers may block out (redact) (1) any confidential premium or pricing information and (2) any wording specific to a project or jurisdiction other than those applicable to this Contract.
- E. Owner shall deliver to Contractor, with copies to each additional insured identified in the Contract, certificates of insurance and endorsements establishing that Owner has obtained and is maintaining the policies and coverages required of Owner by the Contract (if any). Upon request by Contractor or any other insured, Owner shall also provide other evidence of such required insurance (if any), including but not limited to copies of policies, documentation of applicable self-insured retentions (if allowed) and deductibles, and full disclosure of all relevant exclusions. In any documentation furnished under this provision, and subject to Florida’s Public Records Law, Owner may block out (redact) (1) any confidential premium or pricing information and (2) any wording specific to a project or jurisdiction other than those relevant to this Contract.
- F. Failure of Owner or Contractor to demand such certificates or other evidence of the other party’s full compliance with these insurance requirements, or failure of Owner or Contractor to identify a deficiency in compliance from the evidence provided, will not be construed as a waiver of the other party’s obligation to obtain and maintain such insurance.
- G. In addition to the liability insurance required to be provided by Contractor, the Owner, at Owner’s option, may purchase and maintain Owner’s own liability insurance. Owner’s liability policies, if any, operate separately and independently from policies required to be provided by Contractor, and Contractor cannot rely upon Owner’s liability policies for any of Contractor’s obligations to the Owner, Engineer, or third parties.

- H. Contractor shall require:
1. Subcontractors to purchase and maintain worker's compensation, commercial general liability, and other insurance that is appropriate for their participation in the Project, and to name as additional insureds Owner and Engineer (and any other individuals or entities identified in the Supplementary Conditions as additional insureds on Contractor's liability policies) on each Subcontractor's commercial general liability insurance policy; and
 2. Suppliers to purchase and maintain insurance that is appropriate for their participation in the Project.
- I. If either party does not purchase or maintain the insurance required of such party by the Contract, such party shall notify the other party in writing of such failure to purchase prior to the start of the Work, or of such failure to maintain prior to any change in the required coverage.
- J. If Contractor has failed to obtain and maintain required insurance, Contractor's entitlement to enter or remain at the Site will end immediately, and Owner may impose an appropriate set-off against payment for any associated costs (including but not limited to the cost of purchasing necessary insurance coverage), and exercise Owner's termination rights under Article 16.
- K. Without prejudice to any other right or remedy, if a party has failed to obtain required insurance, the other party may elect (but is in no way obligated) to obtain equivalent insurance to protect such other party's interests at the expense of the party who was required to provide such coverage, and the Contract Price will be adjusted accordingly.
- L. Owner does not represent that insurance coverage and limits established in this Contract necessarily will be adequate to protect Contractor or Contractor's interests. Contractor is responsible for determining whether such coverage and limits are adequate to protect its interests, and for obtaining and maintaining any additional insurance that Contractor deems necessary.
- M. The insurance and insurance limits required herein will not be deemed as a limitation on Contractor's liability, or that of its Subcontractors or Suppliers, under the indemnities granted to Owner and other individuals and entities in the Contract or otherwise.
- N. All the policies of insurance required to be purchased and maintained under this Contract will contain a provision or endorsement that the coverage afforded will not be canceled, or renewal refused, until at least ~~10~~ 30 days prior written notice has been given to the purchasing policyholder. Within three days of receipt of any such written notice, the purchasing policyholder shall provide a copy of the notice to each other insured and Engineer.
- O. The fact that an entity or individual is named as an additional insured on a particular insurance policy required under this Contract is not intended to constitute a waiver of any rights of any kind, including subrogation rights, claims for indemnification or any other rights or claims.

6.03 Contractor's Insurance

- A. *Required Insurance:* Contractor shall purchase and maintain Worker's Compensation, Commercial General Liability, and other insurance pursuant to the specific requirements of the Supplementary Conditions.

- B. *General Provisions*: The policies of insurance required by this Paragraph 6.03 as supplemented must:
1. include at least the specific coverages required;
 2. be written for not less than the limits provided, or those required by Laws or Regulations, whichever is greater;
 3. remain in effect at least until the Work is complete (as set forth in Paragraph 15.06.D), and longer if expressly required elsewhere in this Contract, and at all times thereafter when Contractor may be correcting, removing, or replacing defective Work as a warranty or correction obligation, or otherwise, or returning to the Site to conduct other tasks arising from the Contract;
 4. apply with respect to the performance of the Work, whether such performance is by Contractor, any Subcontractor or Supplier, or by anyone directly or indirectly employed by any of them to perform any of the Work, or by anyone for whose acts any of them may be liable; and
 5. include all necessary endorsements to support the stated requirements.
- C. *Additional Insureds*: The Contractor's commercial general liability, automobile liability, employer's liability, umbrella or excess, pollution liability, and unmanned aerial vehicle liability policies, if required by this Contract, must:
1. include and list as additional insureds Owner and Engineer, and any individuals or entities identified as additional insureds in the Supplementary Conditions;
 2. include coverage for the respective supervisors, professional staff, officers, directors, members, partners, employees, agents, subcontractors, and consultants of all such additional insureds;
 3. afford primary coverage to these additional insureds for all claims covered thereby (including as applicable those arising from both ongoing and completed operations);
 4. not seek contribution from insurance maintained by the additional insured; and
 5. as to commercial general liability insurance, apply to additional insureds with respect to liability caused in whole or in part by Contractor's acts or omissions, or the acts and omissions of those working on Contractor's behalf, in the performance of Contractor's operations.

6.04 Builder's Risk and Other Property Insurance

- A. *Builder's Risk*: Unless otherwise provided in the Supplementary Conditions, Contractor shall purchase and maintain builder's risk insurance upon the Work on a completed value basis, in the amount of the Work's full insurable replacement cost (subject to such deductible amounts as may be provided in the Supplementary Conditions or required by Laws and Regulations). The specific requirements applicable to the builder's risk insurance are set forth in the Supplementary Conditions.
- B. *Property Insurance for Facilities of Owner Where Work Will Occur*: Owner is responsible for obtaining and maintaining property insurance covering each existing structure, building, or facility in which any part of the Work will occur, or to which any part of the Work will attach or be adjoined. Such property insurance will be written on a special perils (all-risk) form, on a

replacement cost basis, providing coverage consistent with that required for the builder's risk insurance, and will be maintained until the Work is complete, as set forth in Paragraph 15.06.D.

- ~~C. *Property Insurance for Substantially Complete Facilities:* Promptly after Substantial Completion, and before actual occupancy or use of the substantially completed Work, Owner will obtain property insurance for such substantially completed Work, and maintain such property insurance at least until the Work is complete, as set forth in Paragraph 15.06.D. Such property insurance will be written on a special perils (all-risk) form, on a replacement cost basis, and provide coverage consistent with that required for the builder's risk insurance. The builder's risk insurance may terminate upon written confirmation of Owner's procurement of such property insurance.~~
- D. *Partial Occupancy or Use by Owner:* If Owner will occupy or use a portion or portions of the Work prior to Substantial Completion of all the Work, as provided in Paragraph 15.04, then Owner (directly, if it is the purchaser of the builder's risk policy, or through Contractor) will provide advance notice of such occupancy or use to the builder's risk insurer, and obtain an endorsement consenting to the continuation of coverage prior to commencing such partial occupancy or use.
- E. *Insurance of Other Property; Additional Insurance:* If the express insurance provisions of the Contract do not require or address the insurance of a property item or interest, then the entity or individual owning such property item will be responsible for insuring it. If Contractor elects to obtain other special insurance to be included in or supplement the builder's risk or property insurance policies provided under this Paragraph 6.04, it may do so at Contractor's expense.

6.05 Property Losses; Subrogation

- A. The builder's risk insurance policy purchased and maintained in accordance with Paragraph 6.04 (or an installation floater policy if authorized by the Supplementary Conditions), will contain provisions to the effect that in the event of payment of any loss or damage the insurer will have no rights of recovery against any insureds thereunder, or against Engineer or its consultants, or their officers, directors, members, partners, employees, agents, consultants, or subcontractors.
- ~~1. Owner and Contractor waive-waives all rights against each other and the respective Owner and its officers, directors, members, partners, employees, agents, consultants, and subcontractors of each and any of them, for all losses and damages caused by, arising out of, or resulting from any of the perils, risks, or causes of loss covered by such policies and any other property insurance applicable to the Work; and, in addition, waive-waives all such rights against Engineer and/or Construction Manager, its consultants, all individuals or entities identified in the Supplementary Conditions as builder's risk or installation floater insureds, and the officers, directors, members, partners, employees, agents, consultants, and subcontractors of each and any of them, under such policies for losses and damages so caused.~~
 2. None of the above waivers extends to the rights that any party making such waiver may have to the proceeds of insurance held by Owner or Contractor as trustee or fiduciary, or otherwise payable under any policy so issued.
- B. ~~Any property insurance policy maintained by Owner covering any loss, damage, or consequential loss to Owner's existing structures, buildings, or facilities in which any part of~~

~~the Work will occur, or to which any part of the Work will attach or adjoin; to adjacent structures, buildings, or facilities of Owner; or to part or all of the completed or substantially completed Work, during partial occupancy or use pursuant to Paragraph 15.04, after Substantial Completion pursuant to Paragraph 15.03, or after final payment pursuant to Paragraph 15.06, will contain provisions to the effect that in the event of payment of any loss or damage the insurer will have no rights of recovery against any insureds thereunder, or against Contractor, Subcontractors, or Engineer, or the officers, directors, members, partners, employees, agents, consultants, or subcontractors of each and any of them, and that the insured is allowed to waive the insurer's rights of subrogation in a written contract executed prior to the loss, damage, or consequential loss.~~

- ~~1. Owner waives all rights against Contractor, Subcontractors, and Engineer, and the officers, directors, members, partners, employees, agents, consultants and subcontractors of each and any of them, for all losses and damages caused by, arising out of, or resulting from fire or any of the perils, risks, or causes of loss covered by such policies.~~
- C. The waivers in this Paragraph 6.05 include the waiver of rights due to business interruption, loss of use, or other consequential loss extending beyond direct physical loss or damage to Owner's property or the Work caused by, arising out of, or resulting from fire or other insured peril, risk, or cause of loss.
- D. Contractor shall be responsible for assuring that each Subcontract contains provisions whereby the Subcontractor waives all rights against Owner, Contractor, all individuals or entities identified in the Supplementary Conditions as insureds, the Engineer and its consultants, and the officers, directors, members, partners, employees, agents, consultants, and subcontractors of each and any of them, for all losses and damages caused by, arising out of, relating to, or resulting from fire or other peril, risk, or cause of loss covered by builder's risk insurance, installation floater, and any other property insurance applicable to the Work.

6.06 Receipt and Application of Property Insurance Proceeds

- A. Any insured loss under the builder's risk and other policies of property insurance required by Paragraph 6.04 will be adjusted and settled with the named insured that purchased the policy. Such named insured shall act as fiduciary for the other insureds, and give notice to such other insureds that adjustment and settlement of a claim is in progress. Any other insured may state its position regarding a claim for insured loss in writing within 15 days after notice of such claim.
- B. Proceeds for such insured losses may be made payable by the insurer either jointly to multiple insureds, or to the named insured that purchased the policy in its own right and as fiduciary for other insureds, subject to the requirements of any applicable mortgage clause. A named insured receiving insurance proceeds under the builder's risk and other policies of insurance required by Paragraph 6.04 shall maintain such proceeds in a segregated account, and distribute such proceeds in accordance with such agreement as the parties in interest may reach, or as otherwise required under the dispute resolution provisions of this Contract or applicable Laws and Regulations.
- C. If no other special agreement is reached, Contractor shall repair or replace the damaged Work, using allocated insurance proceeds.

ARTICLE 7—CONTRACTOR’S RESPONSIBILITIES

7.01 Contractor’s Means and Methods of Construction

- A. Contractor shall be solely responsible for the means, methods, techniques, sequences, and procedures of construction.
- B. If the Contract Documents note, or Contractor determines, that professional engineering or other design services are needed to carry out Contractor’s responsibilities for construction means, methods, techniques, sequences, and procedures, or for Site safety, then Contractor shall cause such services to be provided by a properly licensed design professional, at Contractor’s expense. Such services are not Owner-delegated professional design services under this Contract, and neither Owner nor Engineer has any responsibility with respect to (1) Contractor’s determination of the need for such services, (2) the qualifications or licensing of the design professionals retained or employed by Contractor, (3) the performance of such services, or (4) any errors, omissions, or defects in such services.

7.02 Supervision and Superintendence

- A. Contractor shall supervise, inspect, and direct the Work competently and efficiently, devoting such attention thereto and applying such skills and expertise as may be necessary to perform the Work in accordance with the Contract Documents.
- B. At all times during the progress of the Work, Contractor shall assign a competent resident superintendent who will not be replaced without written notice to Owner and Engineer except under extraordinary circumstances.

7.03 Labor; Working Hours

- A. Contractor shall provide competent, suitably qualified personnel to survey and lay out the Work and perform construction as required by the Contract Documents. Contractor shall maintain good discipline and order at the Site.
- B. Contractor shall be fully responsible to Owner and Engineer for all acts and omissions of Contractor’s employees; of Suppliers and Subcontractors, and their employees; and of any other individuals or entities performing or furnishing any of the Work, just as Contractor is responsible for Contractor’s own acts and omissions.
- C. Except as otherwise required for the safety or protection of persons or the Work or property at the Site or adjacent thereto, and except as otherwise stated in the Contract Documents, all Work at the Site ~~will~~ may be performed during regular working hours, Monday through Friday. ~~Contractor will not perform Work on a Saturday, Sunday, or any legal~~ including any holidays as Contractor may choose to do so. Contractor may perform Work outside regular working hours or on Saturdays, Sundays, or legal holidays only with Owner’s written consent, which will not be unreasonably withheld.

The Contractor shall be responsible, whether previously scheduled or not, for the payment of Owner’s cost of overtime inspection outside of the working hours described above. The Contractor will be required to pay for overtime inspection services on unscheduled work, work which is delayed by the Contractor’s suppliers or subcontractors and any other work performed for the convenience of the Contractor as he deems necessary to meet the schedule.

7.04 Services, Materials, and Equipment

- A. Unless otherwise specified in the Contract Documents, Contractor shall provide and assume full responsibility for all services, materials, equipment, labor, transportation, construction equipment and machinery, tools, appliances, fuel, power, light, heat, telephone, water, sanitary facilities, temporary facilities, and all other facilities and incidentals necessary for the performance, testing, start up, and completion of the Work, whether or not such items are specifically called for in the Contract Documents.
- B. All materials and equipment incorporated into the Work must be new and of good quality, except as otherwise provided in the Contract Documents. All special warranties and guarantees required by the Specifications will expressly run to the benefit of Owner. If required by Engineer, Contractor shall furnish satisfactory evidence (including reports of required tests) as to the source, kind, and quality of materials and equipment.
- C. All materials and equipment must be stored, applied, installed, connected, erected, protected, used, cleaned, and conditioned in accordance with instructions of the applicable Supplier, except as otherwise may be provided in the Contract Documents.

7.05 "Or Equals"

- A. *Contractor's Request; Governing Criteria:* Whenever an item of equipment or material is specified or described in the Contract Documents by using the names of one or more proprietary items or specific Suppliers, the Contract Price has been based upon Contractor furnishing such item as specified. The specification or description of such an item is intended to establish the type, function, appearance, and quality required. Unless the specification or description contains or is followed by words reading that no like, equivalent, or "or equal" item is permitted, Contractor may request that Engineer authorize the use of other items of equipment or material, or items from other proposed Suppliers, under the circumstances described below.
 - 1. If Engineer in its sole discretion determines that an item of equipment or material proposed by Contractor is functionally equal to that named and sufficiently similar so that no change in related Work will be required, Engineer will deem it an "or equal" item. For the purposes of this paragraph, a proposed item of equipment or material will be considered functionally equal to an item so named if:
 - a. in the exercise of reasonable judgment Engineer determines that the proposed item:
 - 1) is at least equal in materials of construction, quality, durability, appearance, strength, and design characteristics;
 - 1) will reliably perform at least equally well the function and achieve the results imposed by the design concept of the completed Project as a functioning whole;
 - 2) has a proven record of performance and availability of responsive service; and
 - 3) is not objectionable to Owner.
 - b. Contractor certifies that, if the proposed item is approved and incorporated into the Work:
 - 1) there will be no increase in cost to the Owner or increase in Contract Times; and

- 2) the item will conform substantially to the detailed requirements of the item named in the Contract Documents.
- B. *Contractor's Expense*: Contractor shall provide all data in support of any proposed "or equal" item at Contractor's expense.
- C. *Engineer's Evaluation and Determination*: Engineer will be allowed a reasonable time to evaluate each "or-equal" request. Engineer may require Contractor to furnish additional data about the proposed "or-equal" item. Engineer will be the sole judge of acceptability. No "or-equal" item will be ordered, furnished, installed, or utilized until Engineer's review is complete and Engineer determines that the proposed item is an "or-equal," which will be evidenced by an approved Shop Drawing or other written communication. Engineer will advise Contractor in writing of any negative determination.
- D. *Effect of Engineer's Determination*: Neither approval nor denial of an "or-equal" request will result in any change in Contract Price. The Engineer's denial of an "or-equal" request will be final and binding, and may not be reversed through an appeal under any provision of the Contract.
- E. *Treatment as a Substitution Request*: If Engineer determines that an item of equipment or material proposed by Contractor does not qualify as an "or-equal" item, Contractor may request that Engineer consider the item a proposed substitute pursuant to Paragraph 7.06.

7.06 Substitutes

- A. *Contractor's Request; Governing Criteria*: Unless the specification or description of an item of equipment or material required to be furnished under the Contract Documents contains or is followed by words reading that no substitution is permitted, Contractor may request that Engineer authorize the use of other items of equipment or material under the circumstances described below. To the extent possible such requests must be made before commencement of related construction at the Site.
1. Contractor shall submit sufficient information as provided below to allow Engineer to determine if the item of material or equipment proposed is functionally equivalent to that named and an acceptable substitute therefor. Engineer will not accept requests for review of proposed substitute items of equipment or material from anyone other than Contractor.
 2. The requirements for review by Engineer will be as set forth in Paragraph 7.06.B, as supplemented by the Specifications, and as Engineer may decide is appropriate under the circumstances.
 3. Contractor shall make written application to Engineer for review of a proposed substitute item of equipment or material that Contractor seeks to furnish or use. The application:
 - a. will certify that the proposed substitute item will:
 - 1) perform adequately the functions and achieve the results called for by the general design;
 - 2) be similar in substance to the item specified; and
 - 3) be suited to the same use as the item specified.

- b. will state:
 - 1) the extent, if any, to which the use of the proposed substitute item will necessitate a change in Contract Times;
 - 2) whether use of the proposed substitute item in the Work will require a change in any of the Contract Documents (or in the provisions of any other direct contract with Owner for other work on the Project) to adapt the design to the proposed substitute item; and
 - 3) whether incorporation or use of the proposed substitute item in connection with the Work is subject to payment of any license fee or royalty.
 - c. will identify:
 - 1) all variations of the proposed substitute item from the item specified; and
 - 2) available engineering, sales, maintenance, repair, and replacement services.
 - d. will contain an itemized estimate of all costs or credits that will result directly or indirectly from use of such substitute item, including but not limited to changes in Contract Price, shared savings, costs of redesign, and claims of other contractors affected by any resulting change.
- B. *Engineer's Evaluation and Determination:* Engineer will be allowed a reasonable time to evaluate each substitute request, and to obtain comments and direction from Owner. Engineer may require Contractor to furnish additional data about the proposed substitute item. Engineer will be the sole judge of acceptability. No substitute will be ordered, furnished, installed, or utilized until Engineer's review is complete and Engineer determines that the proposed item is an acceptable substitute. Engineer's determination will be evidenced by a Field Order or a proposed Change Order accounting for the substitution itself and all related impacts, including changes in Contract Price or Contract Times. Engineer will advise Contractor in writing of any negative determination.
- C. *Special Guarantee:* Owner may require Contractor to furnish at Contractor's expense a special performance guarantee or other surety with respect to any substitute.
- D. *Reimbursement of Engineer's Cost:* Engineer will record Engineer's costs in evaluating a substitute proposed or submitted by Contractor. Whether or not Engineer approves a substitute so proposed or submitted by Contractor, Contractor shall reimburse Owner for the reasonable charges of Engineer for evaluating each such proposed substitute. Contractor shall also reimburse Owner for the reasonable charges of Engineer for making changes in the Contract Documents (or in the provisions of any other direct contract with Owner) resulting from the acceptance of each proposed substitute.
- E. *Contractor's Expense:* Contractor shall provide all data in support of any proposed substitute at Contractor's expense.
- F. *Effect of Engineer's Determination:* If Engineer approves the substitution request, Contractor shall execute the proposed Change Order and proceed with the substitution. The Engineer's denial of a substitution request will be final and binding, and may not be reversed through an appeal under any provision of the Contract. Contractor may challenge the scope of reimbursement costs imposed under Paragraph 7.06.D, by timely submittal of a Change Proposal.

7.07 Concerning Subcontractors and Suppliers

- A. Contractor may retain Subcontractors and Suppliers for the performance of parts of the Work. Such Subcontractors and Suppliers must be acceptable to Owner. The Contractor's retention of a Subcontractor or Supplier for the performance of parts of the Work will not relieve Contractor's obligation to Owner to perform and complete the Work in accordance with the Contract Documents.
- B. Contractor shall retain specific Subcontractors and Suppliers for the performance of designated parts of the Work if required by the Contract to do so.
- C. Subsequent to the submittal of Contractor's Bid or final negotiation of the terms of the Contract, Owner may not require Contractor to retain any Subcontractor or Supplier to furnish or perform any of the Work against which Contractor has reasonable objection.
- D. Prior to entry into any binding subcontract or purchase order, Contractor shall submit to Owner the identity of the proposed Subcontractor or Supplier (unless Owner has already deemed such proposed Subcontractor or Supplier acceptable during the bidding process or otherwise). Such proposed Subcontractor or Supplier shall be deemed acceptable to Owner unless Owner raises a substantive, reasonable objection within 5 days.
- E. Owner may require the replacement of any Subcontractor or Supplier. Owner also may require Contractor to retain specific replacements; provided, however, that Owner may not require a replacement to which Contractor has a reasonable objection. If Contractor has submitted the identity of certain Subcontractors or Suppliers for acceptance by Owner, and Owner has accepted it (either in writing or by failing to make written objection thereto), then Owner may subsequently revoke the acceptance of any such Subcontractor or Supplier so identified solely on the basis of substantive, reasonable objection after due investigation. Contractor shall submit an acceptable replacement for the rejected Subcontractor or Supplier.
- F. If Owner requires the replacement of any Subcontractor or Supplier retained by Contractor to perform any part of the Work, then Contractor shall be entitled to an adjustment in Contract Price or Contract Times, with respect to the replacement; and Contractor shall initiate a Change Proposal for such adjustment within 30 days of Owner's requirement of replacement.
- G. No acceptance by Owner of any such Subcontractor or Supplier, whether initially or as a replacement, will constitute a waiver of the right of Owner to the completion of the Work in accordance with the Contract Documents.
- H. On a monthly basis, Contractor shall submit to Engineer a complete list of all Subcontractors and Suppliers having a direct contract with Contractor, and of all other Subcontractors and Suppliers known to Contractor at the time of submittal.
- I. Contractor shall be solely responsible for scheduling and coordinating the work of Subcontractors and Suppliers.
- J. The divisions and sections of the Specifications and the identifications of any Drawings do not control Contractor in dividing the Work among Subcontractors or Suppliers, or in delineating the Work to be performed by any specific trade.

- K. All Work performed for Contractor by a Subcontractor or Supplier must be pursuant to an appropriate contractual agreement that specifically binds the Subcontractor or Supplier to the applicable terms and conditions of the Contract for the benefit of Owner and Engineer.
- L. Owner may furnish to any Subcontractor or Supplier, to the extent practicable, information about amounts paid to Contractor for Work performed for Contractor by the Subcontractor or Supplier.
- M. Contractor shall restrict all Subcontractors and Suppliers from communicating with Engineer or Owner, except through Contractor or in case of an emergency, or as otherwise expressly allowed in this Contract.

7.08 Patent Fees and Royalties

- A. Contractor shall pay all license fees and royalties and assume all costs incident to the use in the performance of the Work or the incorporation in the Work of any invention, design, process, product, or device which is the subject of patent rights or copyrights held by others. If an invention, design, process, product, or device is specified in the Contract Documents for use in the performance of the Work and if, to the actual knowledge of Owner or Engineer, its use is subject to patent rights or copyrights calling for the payment of any license fee or royalty to others, the existence of such rights will be disclosed in the Contract Documents.
- ~~B. To the fullest extent permitted by Laws and Regulations, Owner shall indemnify and hold harmless Contractor, and its officers, directors, members, partners, employees, agents, consultants, and subcontractors, from and against all claims, costs, losses, and damages (including but not limited to all fees and charges of engineers, architects, attorneys, and other professionals, and all court or arbitration or other dispute resolution costs) arising out of or relating to any infringement of patent rights or copyrights incident to the use in the performance of the Work or resulting from the incorporation in the Work of any invention, design, process, product, or device specified in the Contract Documents, but not identified as being subject to payment of any license fee or royalty to others required by patent rights or copyrights.~~
- C. To the fullest extent permitted by Laws and Regulations, Contractor shall indemnify, defend and hold harmless Indemnitees ~~Owner and Engineer, and the officers, directors, members, partners, employees, agents, consultants and subcontractors of each and any of them,~~ from and against all claims, liabilities, suits, liens, demands, costs, losses, interest, expenses, penalties, fines, judgments, and damages (including but not limited to all fees and charges of engineers, architects, attorneys, and other professionals and all court or arbitration or other dispute resolution fees or costs) whether monetary or otherwise, arising, in whole or in part, out of or relating to any infringement of patent rights or copyrights incident to the use in the performance of the Work or resulting from the incorporation in the Work of any invention, design, process, product, or device not specified in the Contract Documents, to the extent such infringement is caused in whole or in part by the negligent, reckless, or intentionally wrongful actions of the Contractor or those for which Contractor is responsible including without limitation, Contractor's successors, assigns, agents, employees, contractors, subcontractors, materialmen, officers, invitees, and representatives.

7.09 Permits

- A. Unless otherwise provided in the Contract Documents, Contractor shall obtain and pay for all construction permits, licenses, and certificates of occupancy. Owner shall assist Contractor, when necessary, in obtaining such permits and licenses. Contractor shall pay all governmental charges and inspection fees necessary for the prosecution of the Work which are applicable at the time of the submission of Contractor's Bid (or when Contractor became bound under a negotiated contract). ~~Owner~~ Contractor shall pay all charges and fees of utility owners for connections for providing permanent service to the Work, including without limitation water and electrical meters (if applicable), installation fees, electrical inspection fees, and temporary services and utilities. Contractor shall additionally provide all signage required by applicable permits and governmental authorities.
- B. Owner and Contractor acknowledge and agree that Owner intends to turn over all or a portion of the Work upon completion to [] County, Florida, for ownership and maintenance. To the extent that Owner intends to turn over any portion of the Work to another governmental entity for ownership or other purposes, Contractor agrees at its sole expense to take all actions necessary (including but not limited to providing all warranties, improvement bonds, and close-out documents required by the governmental entity even if such requirements are beyond what is required herein) to ensure that the recipient governmental entity accepts the Work.

7.10 Taxes

- A. Contractor shall pay all sales, consumer, use, and other similar taxes and assessments required to be paid by Contractor in accordance with the Laws and Regulations of the place of the Project which are applicable during the performance of the Work.

7.11 Laws and Regulations

- A. Contractor shall give all notices required by and shall comply with all Laws and Regulations applicable to the performance of the Work. Neither Owner nor Engineer shall be responsible for monitoring Contractor's compliance with any Laws or Regulations.
- B. If Contractor or those for whom Contractor is responsible performs any Work or takes any other action knowing or having reason to know that it is contrary to Laws or Regulations, Contractor shall bear all resulting costs and losses, and shall indemnify, defend, and hold harmless Indemnitees ~~Owner and Engineer, and the officers, directors, members, partners, employees, agents, consultants, and subcontractors of each and any of them,~~ from and against all claims, liabilities, suits, liens, demands, costs, losses, interest, expenses, penalties, fines, judgments, and damages (including but not limited to all fees and charges of engineers, architects, attorneys, and other professionals and all court or arbitration or other dispute resolution fees or costs) whether monetary or otherwise arising, in whole or in part, out of or relating to such Work or other action. ~~It is not Contractor's responsibility to make certain that the Work described in the Contract Documents is in accordance with Laws and Regulations, but this does not relieve Contractor of its obligations under Paragraph 3.03.~~
- C. Owner or Contractor may give written notice to the other party of any changes after the submission of Contractor's Bid (or after the date when Contractor became bound under a negotiated contract) in Laws or Regulations having an effect on the cost or time of performance of the Work, including but not limited to changes in Laws or Regulations having an effect on procuring permits and on sales, use, value-added, consumption, and other similar

taxes. If Owner and Contractor are unable to agree on entitlement to or on the amount or extent, if any, of any adjustment in Contract Price or Contract Times resulting from such changes, then within 30 days of such written notice Contractor may submit a Change Proposal, or Owner may initiate a Claim.

7.12 Record Documents

- A. Contractor shall maintain in a safe place at the Site one printed record copy of all Drawings, Specifications, Addenda, Change Orders, Work Change Directives, Field Orders, written interpretations and clarifications, and approved Shop Drawings. Contractor shall keep such record documents in good order and annotate them to show changes made during construction. These record documents, together with all approved Samples, will be available to Engineer for reference. Upon completion of the Work, Contractor shall deliver these record documents to Engineer.

7.13 Safety and Protection

- A. Contractor shall be solely responsible for initiating, maintaining, and supervising all safety precautions and programs in connection with the Work. Such responsibility does not relieve Subcontractors of their responsibility for the safety of persons or property in the performance of their work, nor for compliance with applicable safety Laws and Regulations.
- B. Contractor shall designate a qualified and experienced safety representative whose duties and responsibilities are the prevention of Work-related accidents and the maintenance and supervision of safety precautions and programs.
- C. Contractor shall take all necessary precautions for the safety of, and shall provide the necessary protection to prevent damage, injury, or loss to:
 - 1. all persons on the Site or who may be affected by the Work;
 - 2. all the Work and materials and equipment to be incorporated therein, whether in storage on or off the Site; and
 - 3. other property at the Site or adjacent thereto, including trees, shrubs, lawns, walks, pavements, roadways, structures, other work in progress, utilities, and Underground Facilities not designated for removal, relocation, or replacement in the course of construction.
- D. All damage, injury, or loss to any property referred to in Paragraph 7.13.C.2 or 7.13.C.3 caused, directly or indirectly, in whole or in part, by Contractor, any Subcontractor, Supplier, or any other individual or entity directly or indirectly employed by any of them to perform any of the Work, or anyone for whose acts any of them may be liable, shall be remedied by Contractor at its expense (except damage or loss attributable to the fault of Drawings or Specifications or to the acts or omissions of Owner or Engineer or anyone employed by any of them, or anyone for whose acts any of them may be liable, and not attributable, directly or indirectly, in whole or in part, to the fault or negligence of Contractor or any Subcontractor, Supplier, or other individual or entity directly or indirectly employed by any of them).
- E. Contractor shall comply with all applicable Laws and Regulations relating to the safety of persons or property, or to the protection of persons or property from damage, injury, or loss; and shall erect and maintain all necessary safeguards for such safety and protection. Among other requirements, the Contractor or Subcontractor performing trench excavation work on the Project shall comply with the applicable trench safety standards.

- F. Contractor shall notify Owner; the owners of adjacent property; the owners of Underground Facilities and other utilities (if the identity of such owners is known to Contractor); and other contractors and utility owners performing work at or adjacent to the Site, in writing, when Contractor knows that prosecution of the Work may affect them, and shall cooperate with them in the protection, removal, relocation, and replacement of their property or work in progress.
- G. Contractor shall comply with the applicable requirements of Owner's safety programs, if any. Any Owner's safety programs that are applicable to the Work are identified or included in the Supplementary Conditions or Specifications.
- H. Contractor shall inform Owner and Engineer of the specific requirements of Contractor's safety program with which Owner's and Engineer's employees and representatives must comply while at the Site.
- I. Contractor's duties and responsibilities for safety and protection will continue until all the Work is completed, Engineer has issued a written notice to Owner and Contractor in accordance with Paragraph 15.06.C that the Work is acceptable, and Contractor has left the Site (except as otherwise expressly provided in connection with Substantial Completion).
- J. Contractor's duties and responsibilities for safety and protection will resume whenever Contractor or any Subcontractor or Supplier returns to the Site to fulfill warranty or correction obligations, or to conduct other tasks arising from the Contract Documents.

7.14 Hazard Communication Programs

- A. Contractor shall be responsible for coordinating any exchange of safety data sheets (formerly known as material safety data sheets) or other hazard communication information required to be made available to or exchanged between or among employers at the Site in accordance with Laws or Regulations.

7.15 Emergencies

- A. In emergencies affecting the safety or protection of persons or the Work or property at the Site or adjacent thereto, Contractor is obligated to act to prevent damage, injury, or loss. Contractor shall give Engineer prompt written notice if Contractor believes that any significant changes in the Work or variations from the Contract Documents have been caused by an emergency, or are required as a result of Contractor's response to an emergency. If Engineer determines that a change in the Contract Documents is required because of an emergency or Contractor's response, a Work Change Directive or Change Order will be issued.

7.16 Submittals

A. *Shop Drawing and Sample Requirements*

1. Before submitting a Shop Drawing or Sample, Contractor shall:
 - a. review and coordinate the Shop Drawing or Sample with other Shop Drawings and Samples and with the requirements of the Work and the Contract Documents;
 - b. determine and verify:
 - 1) all field measurements, quantities, dimensions, specified performance and design criteria, installation requirements, materials, catalog numbers, and similar information with respect to the Submittal;

- 2) the suitability of all materials and equipment offered with respect to the indicated application, fabrication, shipping, handling, storage, assembly, and installation pertaining to the performance of the Work; and
 - 3) all information relative to Contractor's responsibilities for means, methods, techniques, sequences, and procedures of construction, and safety precautions and programs incident thereto;
 - c. confirm that the Submittal is complete with respect to all related data included in the Submittal.
 2. Each Shop Drawing or Sample must bear a stamp or specific written certification that Contractor has satisfied Contractor's obligations under the Contract Documents with respect to Contractor's review of that Submittal, and that Contractor approves the Submittal.
 3. With each Shop Drawing or Sample, Contractor shall give Engineer specific written notice of any variations that the Submittal may have from the requirements of the Contract Documents. This notice must be set forth in a written communication separate from the Submittal; and, in addition, in the case of a Shop Drawing by a specific notation made on the Shop Drawing itself.
- B. *Submittal Procedures for Shop Drawings and Samples:* Contractor shall label and submit Shop Drawings and Samples to Engineer for review and approval in accordance with the accepted Schedule of Submittals.
 1. *Shop Drawings*
 - a. Contractor shall submit the number of copies required in the Specifications.
 - b. Data shown on the Shop Drawings must be complete with respect to quantities, dimensions, specified performance and design criteria, materials, and similar data to show Engineer the services, materials, and equipment Contractor proposes to provide, and to enable Engineer to review the information for the limited purposes required by Paragraph 7.16.C.
 2. *Samples*
 - a. Contractor shall submit the number of Samples required in the Specifications.
 - b. Contractor shall clearly identify each Sample as to material, Supplier, pertinent data such as catalog numbers, the use for which intended and other data as Engineer may require to enable Engineer to review the Submittal for the limited purposes required by Paragraph 7.16.C.
 3. Where a Shop Drawing or Sample is required by the Contract Documents or the Schedule of Submittals, any related Work performed prior to Engineer's review and approval of the pertinent submittal will be at the sole expense and responsibility of Contractor.
- C. *Engineer's Review of Shop Drawings and Samples*
 1. Engineer will provide timely review of Shop Drawings and Samples in accordance with the accepted Schedule of Submittals. Engineer's review and approval will be only to determine if the items covered by the Submittals will, after installation or incorporation in the Work, comply with the requirements of the Contract Documents, and be

compatible with the design concept of the completed Project as a functioning whole as indicated by the Contract Documents.

2. Engineer's review and approval will not extend to means, methods, techniques, sequences, or procedures of construction, or to safety precautions or programs incident thereto.
3. Engineer's review and approval of a separate item as such will not indicate approval of the assembly in which the item functions.
4. Engineer's review and approval of a Shop Drawing or Sample will not relieve Contractor from responsibility for any variation from the requirements of the Contract Documents unless Contractor has complied with the requirements of Paragraph 7.16.A.3 and Engineer has given written approval of each such variation by specific written notation thereof incorporated in or accompanying the Shop Drawing or Sample. Engineer will document any such approved variation from the requirements of the Contract Documents in a Field Order or other appropriate Contract modification.
5. Engineer's review and approval of a Shop Drawing or Sample will not relieve Contractor from responsibility for complying with the requirements of Paragraphs 7.16.A and B.
6. Engineer's review and approval of a Shop Drawing or Sample, or of a variation from the requirements of the Contract Documents, will not, under any circumstances, change the Contract Times or Contract Price, unless such changes are included in a Change Order.
7. Neither Engineer's receipt, review, acceptance, or approval of a Shop Drawing or Sample will result in such item becoming a Contract Document.
8. Contractor shall perform the Work in compliance with the requirements and commitments set forth in approved Shop Drawings and Samples, subject to the provisions of Paragraph 7.16.C.4.

D. Resubmittal Procedures for Shop Drawings and Samples

1. Contractor shall make corrections required by Engineer and shall return the required number of corrected copies of Shop Drawings and submit, as required, new Samples for review and approval. Contractor shall direct specific attention in writing to revisions other than the corrections called for by Engineer on previous Submittals.
2. Contractor shall furnish required Shop Drawing and Sample submittals with sufficient information and accuracy to obtain required approval of an item with no more than two resubmittals. Engineer will record Engineer's time for reviewing a third or subsequent resubmittal of a Shop Drawing or Sample, and Contractor shall be responsible for Engineer's charges to Owner for such time. Owner may impose a set-off against payments due Contractor to secure reimbursement for such charges.
3. If Contractor requests a change of a previously approved Shop Drawing or Sample, Contractor shall be responsible for Engineer's charges to Owner for its review time, and Owner may impose a set-off against payments due Contractor to secure reimbursement for such charges, unless the need for such change is beyond the control of Contractor.

- E. *Submittals Other than Shop Drawings, Samples, and Owner-Delegated Designs*
1. The following provisions apply to all Submittals other than Shop Drawings, Samples, and Owner-delegated designs:
 - a. Contractor shall submit all such Submittals to the Engineer in accordance with the Schedule of Submittals and pursuant to the applicable terms of the Contract Documents.
 - b. Engineer will provide timely review of all such Submittals in accordance with the Schedule of Submittals and return such Submittals with a notation of either Accepted or Not Accepted. Any such Submittal that is not returned within the time established in the Schedule of Submittals will be deemed accepted.
 - c. Engineer's review will be only to determine if the Submittal is acceptable under the requirements of the Contract Documents as to general form and content of the Submittal.
 - d. If any such Submittal is not accepted, Contractor shall confer with Engineer regarding the reason for the non-acceptance, and resubmit an acceptable document.
 2. Procedures for the submittal and acceptance of the Progress Schedule, the Schedule of Submittals, and the Schedule of Values are set forth in Paragraphs 2.03, 2.04, and 2.05.
- F. Owner-delegated Designs: Submittals pursuant to Owner-delegated designs are governed by the provisions of Paragraph 7.19.

7.17 Contractor's General Warranty and Guarantee

- A. Contractor warrants and guarantees to Owner that all Work will be in accordance with the Contract Documents and will not be defective. Engineer is entitled to rely on Contractor's warranty and guarantee.
- B. Owner's rights under this warranty and guarantee are in addition to, and are not limited by, Owner's rights under the correction period provisions of Paragraph 15.08. The time in which Owner may enforce its warranty and guarantee rights under this Paragraph 7.17 is limited only by applicable Laws and Regulations restricting actions to enforce such rights; provided, however, that after the end of the correction period under Paragraph 15.08:
1. Owner shall give Contractor written notice of any defective Work within 60 days of the discovery that such Work is defective; and
 2. Such notice will be deemed the start of an event giving rise to a Claim under Paragraph 12.01.B, such that any related Claim must be brought within 30 days of the notice.
- C. Contractor's warranty and guarantee hereunder excludes defects or damage caused by:
1. abuse, or improper modification, maintenance, or operation, by persons other than Contractor, Subcontractors, Suppliers, or any other individual or entity for whom Contractor is responsible; or
 2. normal wear and tear under normal usage.
- D. Contractor's obligation to perform and complete the Work in accordance with the Contract Documents is absolute. None of the following will constitute an acceptance of Work that is

not in accordance with the Contract Documents, a release of Contractor's obligation to perform the Work in accordance with the Contract Documents, or a release of Owner's warranty and guarantee rights under this Paragraph 7.17:

1. Observations by Engineer;
 2. Recommendation by Engineer or payment by Owner of any progress or final payment;
 3. The issuance of a certificate of Substantial Completion by Engineer or any payment related thereto by Owner;
 4. Use or occupancy of the Work or any part thereof by Owner;
 5. Any review and approval of a Shop Drawing or Sample submittal;
 6. The issuance of a notice of acceptability by Engineer or other similar acceptance by Owner;
 7. The end of the correction period established in Paragraph 15.08;
 8. Any inspection, test, or approval by others; or
 9. Any correction of defective Work by Owner.
- E. If the Contract requires the Contractor to accept the assignment of a contract entered into by Owner, then the specific warranties, guarantees, and correction obligations contained in the assigned contract will govern with respect to Contractor's performance obligations to Owner for the Work described in the assigned contract.
- F. Contractor shall assign to Owner all warranties extended to Contractor by material suppliers and subcontractors. If an assignment of warranty requires the material supplier or subcontractor to consent to same, then Contractor shall secure the material supplier's or subcontractor's consent to assign said warranties to Owner.
- G. The warranties provided in this Contract shall be in addition to and not in limitation of any other warranty or remedy required by law.

7.18 Indemnification

- A. ~~To the fullest extent permitted by Laws and Regulations, and in addition to any other obligations of Contractor under the Contract or otherwise, Contractor shall indemnify and hold harmless Owner and Engineer, and the officers, directors, members, partners, employees, agents, consultants and subcontractors of each and any of them, from losses, damages, costs, and judgments (including but not limited to all fees and charges of engineers, architects, attorneys, and other professionals, and all court or arbitration or other dispute resolution costs) arising from third party claims or actions relating to or resulting from the performance or furnishing of the Work, provided that any such claim, action, loss, cost, judgment or damage is attributable to bodily injury, sickness, disease, or death, or to damage to or destruction of tangible property (other than the Work itself), including the loss of use resulting therefrom, but only to the extent caused by any negligent act or omission of Contractor, any Subcontractor, any Supplier, or any individual or entity directly or indirectly employed by any of them to perform any of the Work, or anyone for whose acts any of them may be liable.~~

To the fullest extent permitted by Laws and Regulations, and in addition to any other obligations of Contractor under the Contract or otherwise, Contractor shall indemnify, hold harmless, and defend Owner, Engineer, [Landowner] and their respective members, parents, partners, subsidiaries, affiliates, officers, directors, supervisors, managers, attorneys, engineers, consultants, agents, subcontractors and employees, of each and any of all of the foregoing entities and individuals (together, "Indemnitees") from all claims, liabilities, damages, losses, fees, and costs, including, but not limited to, reasonable attorney's fees, to the extent caused, in part or in whole, by the negligence, recklessness, or intentionally wrongful misconduct of the Contractor, or any Subcontractor, any Supplier, or any individual or entity directly or indirectly employed or used by any of them to perform any of the Work.

With respect to any indemnification, defense, and hold harmless provision in this Contract, nothing in this Contract shall be construed to require Contractor to indemnify the District for the District's percentage of fault if the District is adjudged to be more than 50% at fault for any claims against the District and Contractor as jointly liable parties; however, Contractor shall indemnify the District for any and all percentage of fault attributable to Contractor for claims against the District, regardless whether the District is adjudged to be more or less than 50% at fault.

To the extent required by Florida law to make the provisions of any indemnification, defense or hold harmless provision of this Contract enforceable (and otherwise this sentence does not apply), such indemnification, hold harmless and defense obligation shall be \$10,000,000.00 (or the amount of any applicable insurance coverage, if such amount is greater), the amount of which bears a reasonable commercial relationship to the Contract and was part of the project specifications or bid documents. In the event that any indemnification, defense or hold harmless provision of this Contract is determined to be unenforceable, the provision shall be reformed to give the provision the maximum effect allowed by Florida law and for the benefit of the Indemnitees. The Contractor shall ensure that any and all Subcontractors, and Suppliers, include this express paragraph for the benefit of the Indemnitees.

- B. In any and all claims against Owner or Engineer, or any of their officers, directors, members, partners, employees, agents, consultants, or subcontractors, by any employee (or the survivor or personal representative of such employee) of Contractor, any Subcontractor, any Supplier, or any individual or entity directly or indirectly employed by any of them to perform any of the Work, or anyone for whose acts any of them may be liable, the indemnification obligation under Paragraph 7.18.A will not be limited in any way by any limitation on the amount or type of damages, compensation, or benefits payable by or for Contractor or any such Subcontractor, Supplier, or other individual or entity under workers' compensation acts, disability benefit acts, or other employee benefit acts.

7.19 Delegation of Professional Design Services

- A. Owner may require Contractor to provide professional design services for a portion of the Work by express delegation in the Contract Documents. Such delegation will specify the performance and design criteria that such services must satisfy, and the Submittals that Contractor must furnish to Engineer with respect to the Owner-delegated design.
- B. Contractor shall cause such Owner-delegated professional design services to be provided pursuant to the professional standard of care by a properly licensed design professional, whose signature and seal must appear on all drawings, calculations, specifications,

certifications, and Submittals prepared by such design professional. Such design professional must issue all certifications of design required by Laws and Regulations.

- C. If a Shop Drawing or other Submittal related to the Owner-delegated design is prepared by Contractor, a Subcontractor, or others for submittal to Engineer, then such Shop Drawing or other Submittal must bear the written approval of Contractor's design professional when submitted by Contractor to Engineer.
- D. Owner and Engineer shall be entitled to rely upon the adequacy, accuracy, and completeness of the services, certifications, and approvals performed or provided by the design professionals retained or employed by Contractor under an Owner-delegated design, subject to the professional standard of care and the performance and design criteria stated in the Contract Documents.
- E. Pursuant to this Paragraph 7.19, Engineer's review, approval, and other determinations regarding design drawings, calculations, specifications, certifications, and other Submittals furnished by Contractor pursuant to an Owner-delegated design will be only for the following limited purposes:
 - 1. Checking for conformance with the requirements of this Paragraph 7.19;
 - 2. Confirming that Contractor (through its design professionals) has used the performance and design criteria specified in the Contract Documents; and
 - 3. Establishing that the design furnished by Contractor is consistent with the design concept expressed in the Contract Documents.
- F. Contractor shall not be responsible for the adequacy of performance or design criteria specified by Owner or Engineer.
- G. Contractor is not required to provide professional services in violation of applicable Laws and Regulations.

ARTICLE 8—OTHER WORK AT THE SITE

8.01 Other Work

- A. In addition to and apart from the Work under the Contract Documents, the Owner may perform other work at or adjacent to the Site. Such other work may be performed by Owner's employees, or through contracts between the Owner and third parties. Owner may also arrange to have third-party utility owners perform work on their utilities and facilities at or adjacent to the Site.
- B. If Owner performs other work at or adjacent to the Site with Owner's employees, or through contracts for such other work, then Owner shall give Contractor written notice thereof prior to starting any such other work. If Owner has advance information regarding the start of any third-party utility work that Owner has arranged to take place at or adjacent to the Site, Owner shall provide such information to Contractor.
- C. Contractor shall afford proper and safe access to the Site to each contractor that performs such other work, each utility owner performing other work, and Owner, if Owner is performing other work with Owner's employees, and provide a reasonable opportunity for the introduction and storage of materials and equipment and the execution of such other work.

- D. Contractor shall do all cutting, fitting, and patching of the Work that may be required to properly connect or otherwise make its several parts come together and properly integrate with such other work. Contractor shall not endanger any work of others by cutting, excavating, or otherwise altering such work; provided, however, that Contractor may cut or alter others' work with the written consent of Engineer and the others whose work will be affected.
- E. If the proper execution or results of any part of Contractor's Work depends upon work performed by others, Contractor shall inspect such other work and promptly report to Engineer in writing any delays, defects, or deficiencies in such other work that render it unavailable or unsuitable for the proper execution and results of Contractor's Work. Contractor's failure to so report will constitute an acceptance of such other work as fit and proper for integration with Contractor's Work except for latent defects and deficiencies in such other work.
- F. The provisions of this article are not applicable to work that is performed by third-party utilities or other third-party entities without a contract with Owner, or that is performed without having been arranged by Owner. If such work occurs, then any related delay, disruption, or interference incurred by Contractor is governed by the provisions of Paragraph 4.05.C.3.

8.02 Coordination

- A. If Owner intends to contract with others for the performance of other work at or adjacent to the Site, to perform other work at or adjacent to the Site with Owner's employees, or to arrange to have utility owners perform work at or adjacent to the Site, the following will be set forth in the Supplementary Conditions or provided to Contractor prior to the start of any such other work:
 - 1. The identity of the individual or entity that will have authority and responsibility for coordination of the activities among the various contractors;
 - 2. An itemization of the specific matters to be covered by such authority and responsibility; and
 - 3. The extent of such authority and responsibilities.
- B. Unless otherwise provided in the Supplementary Conditions, Owner shall have sole authority and responsibility for such coordination.

8.03 Legal Relationships

- A. If, in the course of performing other work for Owner at or adjacent to the Site, the Owner's employees, any other contractor working for Owner, or any utility owner that Owner has arranged to perform work, causes damage to the Work or to the property of Contractor or its Subcontractors, or delays, disrupts, interferes with, or increases the scope or cost of the performance of the Work, through actions or inaction, then Contractor shall be entitled to an equitable adjustment in the Contract Price or the Contract Times. Contractor must submit any Change Proposal seeking an equitable adjustment in the Contract Price or the Contract Times under this paragraph within 30 days of the damaging, delaying, disrupting, or interfering event. The entitlement to, and extent of, any such equitable adjustment will take into account information (if any) regarding such other work that was provided to Contractor in the Contract Documents prior to the submittal of the Bid or the final negotiation of the terms of the

Contract, and any remedies available to Contractor under Laws or Regulations concerning utility action or inaction. When applicable, any such equitable adjustment in Contract Price will be conditioned on Contractor assigning to Owner all Contractor's rights against such other contractor or utility owner with respect to the damage, delay, disruption, or interference that is the subject of the adjustment. Contractor's entitlement to an adjustment of the Contract Times or Contract Price is subject to the provisions of Paragraphs 4.05.D and 4.05.E.

- B. Contractor shall take reasonable and customary measures to avoid damaging, delaying, disrupting, or interfering with the work of Owner, any other contractor, or any utility owner performing other work at or adjacent to the Site.
1. If Contractor fails to take such measures and as a result damages, delays, disrupts, or interferes with the work of any such other contractor or utility owner, then Owner may impose a set-off against payments due Contractor, and assign to such other contractor or utility owner the Owner's contractual rights against Contractor with respect to the breach of the obligations set forth in this Paragraph 8.03.B.
 2. When Owner is performing other work at or adjacent to the Site with Owner's employees, Contractor shall be liable to Owner for damage to such other work, and for the reasonable direct delay, disruption, and interference costs incurred by Owner as a result of Contractor's failure to take reasonable and customary measures with respect to Owner's other work. In response to such damage, delay, disruption, or interference, Owner may impose a set-off against payments due Contractor.
- C. If Contractor damages, delays, disrupts, or interferes with the work of any other contractor, or any utility owner performing other work at or adjacent to the Site, through Contractor's failure to take reasonable and customary measures to avoid such impacts, or if any claim arising, in whole or in part, out of Contractor's actions, inactions, ~~or~~ negligence, recklessness, or intentional misconduct in performance of the Work at or adjacent to the Site is made by any such other contractor or utility owner against Contractor, Owner, or Engineer, then Contractor shall (1) promptly attempt to settle the claim as to all parties through negotiations with such other contractor or utility owner, or otherwise resolve the claim by arbitration or other dispute resolution proceeding or at law, and (2) indemnify, defend, and hold harmless Indemnitees Owner and Engineer, and the officers, directors, members, partners, employees, agents, consultants and subcontractors of each and any of them from and against any such claims, and against all costs, liabilities, suits, liens, demands, interest, expenses, penalties, fines, judgments, costs, losses, and damages (including but not limited to all fees and charges of engineers, architects, attorneys, and other professionals and all court or arbitration or other dispute resolution fees and costs) whether monetary or otherwise, arising out of or relating to such damage, delay, disruption, or interference.

ARTICLE 9—OWNER'S RESPONSIBILITIES

9.01 Communications to Contractor

- A. Except as otherwise provided in these General Conditions, Owner shall issue all communications to Contractor through Engineer.

- 9.02 Replacement of Engineer
- A. Owner may at its discretion appoint an engineer to replace Engineer, provided Contractor makes no reasonable objection to the replacement engineer. The replacement engineer's status under the Contract Documents will be that of the former Engineer.
- 9.03 Furnish Data
- A. Owner shall promptly furnish the data required of Owner under the Contract Documents.
- 9.04 Pay When Due
- A. Owner shall make payments to Contractor when they are due as provided in the Agreement.
- 9.05 Lands and Easements; Reports, Tests, and Drawings
- A. Owner's duties with respect to providing lands and easements are set forth in Paragraph 5.01.
- B. Owner's duties with respect to providing engineering surveys to establish reference points are set forth in Paragraph 4.03.
- C. Article 5 refers to Owner's identifying and making available to Contractor copies of reports of explorations and tests of conditions at the Site, and drawings of physical conditions relating to existing surface or subsurface structures at the Site.
- 9.06 Insurance
- A. Owner's responsibilities, if any, with respect to purchasing and maintaining liability and property insurance are set forth in Article 6.
- 9.07 Change Orders
- A. Owner's responsibilities with respect to Change Orders are set forth in Article 11.
- 9.08 Inspections, Tests, and Approvals
- A. Owner's responsibility with respect to certain inspections, tests, and approvals is set forth in Paragraph 14.02.B.
- 9.09 Limitations on Owner's Responsibilities
- A. The Owner shall not supervise, direct, or have control or authority over, nor be responsible for, Contractor's means, methods, techniques, sequences, or procedures of construction, or the safety precautions and programs incident thereto, or for any failure of Contractor to comply with Laws and Regulations applicable to the performance of the Work. Owner will not be responsible for Contractor's failure to perform the Work in accordance with the Contract Documents.
- 9.10 Undisclosed Hazardous Environmental Condition
- A. Owner's responsibility in respect to an undisclosed Hazardous Environmental Condition is set forth in Paragraph 5.06.
- 9.11 Evidence of Financial Arrangements
- A. Upon request of Contractor, Owner shall furnish Contractor reasonable evidence that financial arrangements have been made to satisfy Owner's obligations under the Contract (including obligations under proposed changes in the Work).

9.12 Safety Programs

- A. While at the Site, Owner's employees and representatives shall comply with the specific applicable requirements of Contractor's safety programs of which Owner has been informed.
- B. Owner shall furnish copies of any applicable Owner safety programs to Contractor.

ARTICLE 10—ENGINEER'S STATUS DURING CONSTRUCTION

10.01 Owner's Representative

- A. Engineer and the Construction Manager, if any, will be Owner's representative during the construction period. The duties and responsibilities and the limitations of authority of Engineer as Owner's representative during construction are set forth in the Contract.

10.02 Visits to Site

- A. Engineer will make visits to the Site at intervals appropriate to the various stages of construction as Engineer deems necessary in order to observe, as an experienced and qualified design professional, the progress that has been made and the quality of the various aspects of Contractor's executed Work. Based on information obtained during such visits and observations, Engineer, for the benefit of Owner, will determine, in general, if the Work is proceeding in accordance with the Contract Documents. Engineer will not be required to make exhaustive or continuous inspections on the Site to check the quality or quantity of the Work. Engineer's efforts will be directed toward providing for Owner a greater degree of confidence that the completed Work will conform generally to the Contract Documents. On the basis of such visits and observations, Engineer will keep Owner informed of the progress of the Work and will endeavor to guard Owner against defective Work.
- B. Engineer's visits and observations are subject to all the limitations on Engineer's authority and responsibility set forth in Paragraph 10.07. Particularly, but without limitation, during or as a result of Engineer's visits or observations of Contractor's Work, Engineer will not supervise, direct, control, or have authority over or be responsible for Contractor's means, methods, techniques, sequences, or procedures of construction, or the safety precautions and programs incident thereto, or for any failure of Contractor to comply with Laws and Regulations applicable to the performance of the Work.

10.03 Resident Project Representative

- A. If Owner and Engineer have agreed that Engineer will furnish a Resident Project Representative to represent Engineer at the Site and assist Engineer in observing the progress and quality of the Work, then the authority and responsibilities of any such Resident Project Representative will be as provided in the Supplementary Conditions, and limitations on the responsibilities thereof will be as provided in the Supplementary Conditions and in Paragraph 10.07.
- B. If Owner designates an individual or entity who is not Engineer's consultant, agent, or employee to represent Owner at the Site, then the responsibilities and authority of such individual or entity will be as provided in the Supplementary Conditions.

10.04 Engineer's Authority

- A. Engineer has the authority to reject Work in accordance with Article 14.

- B. Engineer's authority as to Submittals is set forth in Paragraph 7.16.
- C. Engineer's authority as to design drawings, calculations, specifications, certifications and other Submittals from Contractor in response to Owner's delegation (if any) to Contractor of professional design services, is set forth in Paragraph 7.19.
- D. Engineer's authority as to changes in the Work is set forth in Article 11.
- E. Engineer's authority as to Applications for Payment is set forth in Article 15.

10.05 Determinations for Unit Price Work

- A. Engineer will determine the actual quantities and classifications of Unit Price Work performed by Contractor as set forth in Paragraph 13.03.

10.06 Decisions on Requirements of Contract Documents and Acceptability of Work

- A. Engineer will render decisions regarding the requirements of the Contract Documents, and judge the acceptability of the Work, pursuant to the specific procedures set forth herein for initial interpretations, Change Proposals, and acceptance of the Work. In rendering such decisions and judgments, Engineer will not show partiality to Owner or Contractor, and will not be liable to Owner, Contractor, or others in connection with any proceedings, interpretations, decisions, or judgments conducted or rendered in good faith.

10.07 Limitations on Engineer's Authority and Responsibilities

- A. Neither Engineer's authority or responsibility under this Article 10 or under any other provision of the Contract, nor any decision made by Engineer in good faith either to exercise or not exercise such authority or responsibility or the undertaking, exercise, or performance of any authority or responsibility by Engineer, will create, impose, or give rise to any duty in contract, tort, or otherwise owed by Engineer to Contractor, any Subcontractor, any Supplier, any other individual or entity, or to any surety for or employee or agent of any of them.
- B. Engineer will not supervise, direct, control, or have authority over or be responsible for Contractor's means, methods, techniques, sequences, or procedures of construction, or the safety precautions and programs incident thereto, or for any failure of Contractor to comply with Laws and Regulations applicable to the performance of the Work. Engineer will not be responsible for Contractor's failure to perform the Work in accordance with the Contract Documents.
- C. Engineer will not be responsible for the acts or omissions of Contractor or of any Subcontractor, any Supplier, or of any other individual or entity performing any of the Work.
- D. Engineer's review of the final Application for Payment and accompanying documentation, and all maintenance and operating instructions, schedules, guarantees, bonds, certificates of inspection, tests and approvals, and other documentation required to be delivered by Contractor under Paragraph 15.06.A, will only be to determine generally that their content complies with the requirements of, and in the case of certificates of inspections, tests, and approvals, that the results certified indicate compliance with the Contract Documents.
- E. The limitations upon authority and responsibility set forth in this Paragraph 10.07 also apply to the Resident Project Representative, if any.

10.08 Compliance with Safety Program

- A. While at the Site, Engineer's employees and representatives will comply with the specific applicable requirements of Owner's and Contractor's safety programs of which Engineer has been informed.

ARTICLE 11—CHANGES TO THE CONTRACT

11.01 Amending and Supplementing the Contract

- A. The Contract may be amended or supplemented by a Change Order, a Work Change Directive, or a Field Order.
- B. If an amendment or supplement to the Contract includes a change in the Contract Price or the Contract Times, such amendment or supplement must be set forth in a Change Order.
- C. All changes to the Contract that involve (1) the performance or acceptability of the Work, (2) the design (as set forth in the Drawings, Specifications, or otherwise), or (3) other engineering or technical matters, must be supported by Engineer's recommendation. Owner and Contractor may amend other terms and conditions of the Contract without the recommendation of the Engineer. Such an amendment shall be set forth in a Change Order or a Work Change Directive.

11.02 Change Orders

- A. Owner and Contractor shall execute appropriate Change Orders covering:
 - 1. Changes in Contract Price or Contract Times which are agreed to by the parties, including any undisputed sum or amount of time for Work actually performed in accordance with a Work Change Directive;
 - 2. Changes in Contract Price resulting from an Owner set-off, unless Contractor has duly contested such set-off;
 - 3. Changes in the Work which are: (a) ordered by Owner pursuant to Paragraph 11.05, (b) required because of Owner's acceptance of defective Work under Paragraph 14.04 or Owner's correction of defective Work under Paragraph 14.07, or (c) agreed to by the parties, subject to the need for Engineer's recommendation if the change in the Work involves the design (as set forth in the Drawings, Specifications, or otherwise) or other engineering or technical matters; such requests for Change Orders may be submitted by Construction Manager in consultation with the Contractor; however, all Change Orders must be reviewed and approved by the Engineer prior to final sign off by the Owner and implementation of the same; and
 - 4. Changes that embody the substance of any final and binding results under: Paragraph 11.03.B, resolving the impact of a Work Change Directive; Paragraph 11.09, concerning Change Proposals; Article 12, Claims; Paragraph 13.02.D, final adjustments resulting from allowances; Paragraph 13.03.D, final adjustments relating to determination of quantities for Unit Price Work; and similar provisions.
- ~~B. If Owner or Contractor refuses to execute a Change Order that is required to be executed under the terms of Paragraph 11.02.A, it will be deemed to be of full force and effect, as if fully executed.~~

11.03 Work Change Directives

- A. A Work Change Directive will not change the Contract Price or the Contract Times but is evidence that the parties expect that the modification ordered or documented by a Work Change Directive will be incorporated in a subsequently issued Change Order, following negotiations by the parties as to the Work Change Directive's effect, if any, on the Contract Price and Contract Times; or, if negotiations are unsuccessful, by a determination under the terms of the Contract Documents governing adjustments, expressly including Paragraph 11.07 regarding change of Contract Price.
- B. If Owner has issued a Work Change Directive and:
 - 1. Contractor believes that an adjustment in Contract Times or Contract Price is necessary, then Contractor shall submit any Change Proposal seeking such an adjustment no later than 30 days after the completion of the Work set out in the Work Change Directive.
 - 2. Owner believes that an adjustment in Contract Times or Contract Price is necessary, then Owner shall submit any Claim seeking such an adjustment no later than 60 days after issuance of the Work Change Directive.

11.04 Field Orders

- A. Engineer may authorize minor changes in the Work if the changes do not involve an adjustment in the Contract Price or the Contract Times and are compatible with the design concept of the completed Project as a functioning whole as indicated by the Contract Documents. Such changes will be accomplished by a Field Order and will be binding on Owner and also on Contractor, which shall perform the Work involved promptly.
- B. If Contractor believes that a Field Order justifies an adjustment in the Contract Price or Contract Times, then before proceeding with the Work at issue, Contractor shall submit a Change Proposal as provided herein.

11.05 Owner-Authorized Changes in the Work

- A. Without invalidating the Contract and without notice to any surety, Owner may, at any time or from time to time, order additions, deletions, or revisions in the Work including but not limited to for the purposes of achieving cost savings, and Owner reserves the right to delete portions of the Work and contract with third parties to provide any such deleted Work. Changes involving the design (as set forth in the Drawings, Specifications, or otherwise) or other engineering or technical matters will be supported by Engineer's recommendation.
- B. Such changes in the Work may be accomplished by a Change Order, if Owner and Contractor have agreed as to the effect, if any, of the changes on Contract Times or Contract Price; or by a Work Change Directive. Upon receipt of any such document, Contractor shall promptly proceed with the Work involved; or, in the case of a deletion in the Work, promptly cease construction activities with respect to such deleted Work. Added or revised Work must be performed under the applicable conditions of the Contract Documents.
- C. Nothing in this Paragraph 11.05 obligates Contractor to undertake work that Contractor reasonably concludes cannot be performed in a manner consistent with Contractor's safety obligations under the Contract Documents or Laws and Regulations.

11.06 Unauthorized Changes in the Work

- A. Contractor shall not be entitled to an increase in the Contract Price or an extension of the Contract Times with respect to any work performed that is not required by the Contract Documents, as amended, modified, or supplemented, except in the case of an emergency as provided in Paragraph 7.15 or in the case of uncovering Work as provided in Paragraph 14.05.C.2.

11.07 Change of Contract Price

- A. The Contract Price may only be changed by a Change Order. Any Change Proposal for an adjustment in the Contract Price must comply with the provisions of Paragraph 11.09. Any Claim for an adjustment of Contract Price must comply with the provisions of Article 12.
- B. An adjustment in the Contract Price will be determined as follows:
 1. Where the Work involved is covered by unit prices contained in the Contract Documents, then by application of such unit prices to the quantities of the items involved (subject to the provisions of Paragraph 13.03);
 2. Where the Work involved is not covered by unit prices contained in the Contract Documents, then by a mutually agreed lump sum (which may include an allowance for overhead and profit not necessarily in accordance with Paragraph 11.07.C.2); or
 3. ~~Where the Work involved is not covered by unit prices contained in the Contract Documents and the parties do not reach mutual agreement to a lump sum, then on the basis of the Cost of the Work (determined as provided in Paragraph 13.01) plus a Contractor's fee for overhead and profit (determined as provided in Paragraph 11.07.C).~~
- C. *Contractor's Fee*: When applicable, the Contractor's fee for overhead and profit will be determined as follows:
 1. A mutually acceptable fixed fee; or
 2. If a fixed fee is not agreed upon, then a fee based on the following percentages of the various portions of the Cost of the Work:
 - a. For costs incurred under Paragraphs 13.01.B.1 and 13.01.B.2, the Contractor's fee will be 15 percent;
 - b. For costs incurred under Paragraph 13.01.B.3, the Contractor's fee will be 5 percent;
 - c. Where one or more tiers of subcontracts are on the basis of Cost of the Work plus a fee and no fixed fee is agreed upon, the intent of Paragraphs 11.07.C.2.a and 11.07.C.2.b is that the Contractor's fee will be based on: (1) a fee of 15 percent of the costs incurred under Paragraphs 13.01.B.1 and 13.01.B.2 by the Subcontractor that actually performs the Work, at whatever tier, and (2) with respect to Contractor itself and to any Subcontractors of a tier higher than that of the Subcontractor that actually performs the Work, a fee of 5 percent of the amount (fee plus underlying costs incurred) attributable to the next lower tier Subcontractor; provided, however, that for any such subcontracted Work the maximum total fee to be paid by Owner will be no greater than 27 percent of the costs incurred by the Subcontractor that actually performs the Work;

- d. No fee will be payable on the basis of costs itemized under Paragraphs 13.01.B.4, 13.01.B.5, and 13.01.C;
- e. The amount of credit to be allowed by Contractor to Owner for any change which results in a net decrease in Cost of the Work will be the amount of the actual net decrease in Cost of the Work and a deduction of an additional amount equal to 5 percent of such actual net decrease in Cost of the Work; and
- f. When both additions and credits are involved in any one change or Change Proposal, the adjustment in Contractor's fee will be computed by determining the sum of the costs in each of the cost categories in Paragraph 13.01.B (specifically, payroll costs, Paragraph 13.01.B.1; incorporated materials and equipment costs, Paragraph 13.01.B.2; Subcontract costs, Paragraph 13.01.B.3; special consultants costs, Paragraph 13.01.B.4; and other costs, Paragraph 13.01.B.5) and applying to each such cost category sum the appropriate fee from Paragraphs 11.07.C.2.a through 11.07.C.2.e, inclusive.

11.08 Change of Contract Times

- A. The Contract Times may only be changed by a Change Order. Any Change Proposal for an adjustment in the Contract Times must comply with the provisions of Paragraph 11.09. Any Claim for an adjustment in the Contract Times must comply with the provisions of Article 12.
- B. Delay, disruption, and interference in the Work, and any related changes in Contract Times, are addressed in and governed by Paragraph 4.05.

11.09 Change Proposals

- A. *Purpose and Content:* Contractor shall submit a Change Proposal to Engineer to request an adjustment in the Contract Times or Contract Price; contest an initial decision by Engineer concerning the requirements of the Contract Documents or relating to the acceptability of the Work under the Contract Documents; challenge a set-off against payment due; or seek other relief under the Contract. The Change Proposal will specify any proposed change in Contract Times or Contract Price, or other proposed relief, and explain the reason for the proposed change, with citations to any governing or applicable provisions of the Contract Documents. Each Change Proposal will address only one issue, or a set of closely related issues.
- B. *Change Proposal Procedures*
 - 1. *Submittal:* Contractor shall submit each Change Proposal to Engineer within 30 days after the start of the event giving rise thereto, or after such initial decision.
 - 2. *Supporting Data:* The Contractor shall submit supporting data, including the proposed change in Contract Price or Contract Time (if any), to the Engineer and Owner within 15 days after the submittal of the Change Proposal.
 - a. Change Proposals based on or related to delay, interruption, or interference must comply with the provisions of Paragraphs 4.05.D and 4.05.E.
 - b. Change proposals related to a change of Contract Price must include full and detailed accounts of materials incorporated into the Work and labor and equipment used for the subject Work.

The supporting data must be accompanied by a written statement that the supporting data are accurate and complete, and that any requested time or price adjustment is the entire adjustment to which Contractor believes it is entitled as a result of said event.

3. *Engineer's Initial Review:* Engineer will advise Owner regarding the Change Proposal, and consider any comments or response from Owner regarding the Change Proposal. If in its discretion Engineer concludes that additional supporting data is needed before conducting a full review and making a decision regarding the Change Proposal, then Engineer may request that Contractor submit such additional supporting data by a date specified by Engineer, prior to Engineer beginning its full review of the Change Proposal.
 4. *Engineer's Full Review and Action on the Change Proposal:* Upon receipt of Contractor's supporting data (including any additional data requested by Engineer), Engineer will conduct a full review of each Change Proposal and, within 30 days after such receipt of the Contractor's supporting data, either approve the Change Proposal in whole, deny it in whole, or approve it in part and deny it in part. Such actions must be in writing, with a copy provided to Owner and Contractor. If Engineer does not take action on the Change Proposal within 30 days, then either Owner or Contractor may at any time thereafter submit a letter to the other party indicating that as a result of Engineer's inaction the Change Proposal is deemed denied, thereby commencing the time for appeal of the denial under Article 12.
 5. *Binding Decision:* Engineer's decision is final and binding upon Owner and Contractor, unless Owner or Contractor appeals the decision by filing a Claim under Article 12.
- C. *Resolution of Certain Change Proposals:* If the Change Proposal does not involve the design (as set forth in the Drawings, Specifications, or otherwise), the acceptability of the Work, or other engineering or technical matters, then Engineer will notify the parties in writing that the Engineer is unable to resolve the Change Proposal. For purposes of further resolution of such a Change Proposal, such notice will be deemed a denial, and Contractor may choose to seek resolution under the terms of Article 12.
- D. *Post-Completion:* Contractor shall not submit any Change Proposals after Engineer issues a written recommendation of final payment pursuant to Paragraph 15.06.B.

11.10 Notification to Surety

- A. If the provisions of any bond require notice to be given to a surety of any change affecting the general scope of the Work or the provisions of the Contract Documents (including, but not limited to, Contract Price or Contract Times), the giving of any such notice will be Contractor's responsibility. The amount of each applicable bond will be adjusted to reflect the effect of any such change.

ARTICLE 12—CLAIMS

12.01 Claims

- A. *Claims Process:* The following disputes between Owner and Contractor are subject to the Claims process set forth in this article:
1. Appeals by Owner or Contractor of Engineer's decisions regarding Change Proposals;

2. Owner demands for adjustments in the Contract Price or Contract Times, or other relief under the Contract Documents;
 3. Disputes that Engineer has been unable to address because they do not involve the design (as set forth in the Drawings, Specifications, or otherwise), the acceptability of the Work, or other engineering or technical matters; and
 4. Subject to the waiver provisions of Paragraph 15.07, any dispute arising after Engineer has issued a written recommendation of final payment pursuant to Paragraph 15.06.B.
- B. *Submittal of Claim:* The party submitting a Claim shall deliver such claim, in writing, directly to the other party to the Contract promptly (but in no event later than 30 days) after the start of the event giving rise thereto; in the case of appeals regarding Change Proposals within 30 days of the decision under appeal. The party submitting the Claim shall also furnish a copy to the Engineer, for its information only. The responsibility to substantiate a Claim rests with the party making the Claim. In the case of a Claim by Contractor seeking an increase in the Contract Times or Contract Price, Contractor shall certify that the Claim is made in good faith, that the supporting data are accurate and complete, and that to the best of Contractor's knowledge and belief the amount of time or money requested accurately reflects the full amount to which Contractor is entitled.
- C. *Review and Resolution:* The party receiving a Claim shall review it thoroughly, giving full consideration to its merits. The two parties shall seek to resolve the Claim through the exchange of information and direct negotiations. The parties may extend the time for resolving the Claim by mutual agreement. All actions taken on a Claim will be stated in writing and submitted to the other party, with a copy to Engineer.
- D. *Mediation*
1. At any time after initiation of a Claim, Owner and Contractor may mutually agree to mediation of the underlying dispute. The agreement to mediate will stay the Claim submittal and response process.
 2. If Owner and Contractor agree to mediation, then after 60 days from such agreement, either Owner or Contractor may unilaterally terminate the mediation process, and the Claim submittal and decision process will resume as of the date of the termination. If the mediation proceeds but is unsuccessful in resolving the dispute, the Claim submittal and decision process will resume as of the date of the conclusion of the mediation, as determined by the mediator.
 3. Owner and Contractor shall each pay one-half of the mediator's fees and costs.
- E. *Partial Approval:* If the party receiving a Claim approves the Claim in part and denies it in part, such action will be final and binding unless within 30 days of such action the other party invokes the procedure set forth in Article 17 for final resolution of disputes.
- F. *Denial of Claim:* If efforts to resolve a Claim are not successful, the party receiving the Claim may deny it by giving written notice of denial to the other party. If the receiving party does not take action on the Claim within 90 days, then either Owner or Contractor may at any time thereafter submit a letter to the other party indicating that as a result of the inaction, the Claim is deemed denied, thereby commencing the time for appeal of the denial. A denial of the Claim will be final and binding unless within 30 days of the denial the other party invokes the procedure set forth in Article 17 for the final resolution of disputes.

- G. *Final and Binding Results*: If the parties reach a mutual agreement regarding a Claim, whether through approval of the Claim, direct negotiations, mediation, or otherwise; or if a Claim is approved in part and denied in part, or denied in full, and such actions become final and binding; then the results of the agreement or action on the Claim will be incorporated in a Change Order or other written document to the extent they affect the Contract, including the Work, the Contract Times, or the Contract Price.

ARTICLE 13—COST OF THE WORK; ALLOWANCES; UNIT PRICE WORK

13.01 Cost of the Work

- A. *Purposes for Determination of Cost of the Work*: The term Cost of the Work means the sum of all costs necessary for the proper performance of the Work at issue, as further defined below. The provisions of this Paragraph 13.01 are used for two distinct purposes:
1. ~~To determine Cost of the Work when Cost of the Work is a component of the Contract Price, under cost plus fee, time and materials, or other cost based terms; or~~
 2. When needed to determine the value of a Change Order, Change Proposal, Claim, set-off, or other adjustment in Contract Price. When the value of any such adjustment is determined on the basis of Cost of the Work, Contractor is entitled only to those additional or incremental costs required because of the change in the Work or because of the event giving rise to the adjustment.
- B. *Costs Included*: Except as otherwise may be agreed to in writing by Owner, costs included in the Cost of the Work will be in amounts no higher than those commonly incurred in the locality of the Project, will not include any of the costs itemized in Paragraph 13.01.C, and will include only the following items:
1. Payroll costs for employees in the direct employ of Contractor in the performance of the Work under schedules of job classifications agreed upon by Owner and Contractor in advance of the subject Work. Such employees include, without limitation, superintendents, foremen, safety managers, safety representatives, and other personnel employed full time on the Work. Payroll costs for employees not employed full time on the Work will be apportioned on the basis of their time spent on the Work. Payroll costs include, but are not limited to, salaries and wages plus the cost of fringe benefits, which include social security contributions, unemployment, excise, and payroll taxes, workers' compensation, health and retirement benefits, sick leave, and vacation and holiday pay applicable thereto. The expenses of performing Work outside of regular working hours, on Saturday, Sunday, or legal holidays, will be included in the above to the extent authorized by Owner.
 2. Cost of all materials and equipment furnished and incorporated in the Work, including costs of transportation and storage thereof, and Suppliers' field services required in connection therewith. All cash discounts accrue to Contractor unless Owner deposits funds with Contractor with which to make payments, in which case the cash discounts will accrue to Owner. All trade discounts, rebates, and refunds and returns from sale of surplus materials and equipment will accrue to Owner, and Contractor shall make provisions so that they may be obtained.
 3. Payments made by Contractor to Subcontractors for Work performed by Subcontractors. If required by Owner, Contractor shall obtain competitive bids from subcontractors

acceptable to Owner and Contractor and shall deliver such bids to Owner, which will then determine, with the advice of Engineer, which bids, if any, will be acceptable. If any subcontract provides that the Subcontractor is to be paid on the basis of Cost of the Work plus a fee, the Subcontractor's Cost of the Work and fee will be determined in the same manner as Contractor's Cost of the Work and fee as provided in this Paragraph 13.01.

4. Costs of special consultants (including but not limited to engineers, architects, testing laboratories, surveyors, attorneys, and accountants) employed or retained for services specifically related to the Work.
5. Other costs consisting of the following:
 - a. ~~The proportion of necessary transportation, travel, and subsistence expenses of Contractor's employees incurred in discharge of duties connected with the Work.~~
 - b. Cost, including transportation and maintenance, of all materials, supplies, equipment, machinery, appliances, office, and temporary facilities at the Site, which are consumed in the performance of the Work, and cost, less market value, of such items used but not consumed which remain the property of Contractor.
 - 4) 1) In establishing included costs for materials such as scaffolding, plating, or sheeting, consideration will be given to the actual or the estimated life of the material for use on other projects; or rental rates may be established on the basis of purchase or salvage value of such items, whichever is less. Contractor will not be eligible for compensation for such items in an amount that exceeds the purchase cost of such item.
 - c. *Construction Equipment Rental*
 - 5) 1) Rentals of all construction equipment and machinery, and the parts thereof, in accordance with rental agreements approved by Owner as to price (including any surcharge or special rates applicable to overtime use of the construction equipment or machinery), and the costs of transportation, loading, unloading, assembly, dismantling, and removal thereof. All such costs will be in accordance with the terms of said rental agreements. The rental of any such equipment, machinery, or parts must cease when the use thereof is no longer necessary for the Work.
 - 6) 2) Costs for equipment and machinery owned by Contractor or a Contractor-related entity will be paid at a rate shown for such equipment in the equipment rental rate book specified in the Supplementary Conditions, or if none is specified, in a rate book mutually acceptable to both parties. An hourly rate will be computed by dividing the monthly rates by 176. These computed rates will include all operating costs.
 - 7) 3) With respect to Work that is the result of a Change Order, Change Proposal, Claim, set-off, or other adjustment in Contract Price ("changed Work"), included costs will be based on the time the equipment or machinery is in use on the changed Work and the costs of transportation, loading, unloading, assembly, dismantling, and removal when directly attributable to the changed Work. The cost of any such equipment or machinery, or parts thereof, must cease to accrue when the use thereof is no longer necessary for the changed Work.

- d. Sales, consumer, use, and other similar taxes related to the Work, and for which Contractor is liable, as imposed by Laws and Regulations.
 - e. Deposits lost for causes other than negligence of Contractor, any Subcontractor, or anyone directly or indirectly employed by any of them or for whose acts any of them may be liable, and royalty payments and fees for permits and licenses.
 - f. Losses and damages (and related expenses) caused by damage to the Work, not compensated by insurance or otherwise, sustained by Contractor in connection with the performance of the Work (except losses and damages within the deductible amounts of builder's risk or other property insurance established in accordance with Paragraph 6.04), provided such losses and damages have resulted from causes other than the negligence of Contractor, any Subcontractor, or anyone directly or indirectly employed by any of them or for whose acts any of them may be liable. Such losses include settlements made with the written consent and approval of Owner. No such losses, damages, and expenses will be included in the Cost of the Work for the purpose of determining Contractor's fee.
 - g. The cost of utilities, fuel, and sanitary facilities at the Site.
 - ~~h. Minor expenses such as communication service at the Site, express and courier services, and similar petty cash items in connection with the Work.~~
 - i. The costs of premiums for all bonds and insurance that Contractor is required by the Contract Documents to purchase and maintain.
- C. *Costs Excluded*: The term Cost of the Work does not include any of the following items:
1. Payroll costs and other compensation of Contractor's officers, executives, principals, general managers, engineers, architects, estimators, attorneys, auditors, accountants, purchasing and contracting agents, expeditors, timekeepers, clerks, and other personnel employed by Contractor, whether at the Site or in Contractor's principal or branch office for general administration of the Work and not specifically included in the agreed upon schedule of job classifications referred to in Paragraph 13.01.B.1 or specifically covered by Paragraph 13.01.B.4. The payroll costs and other compensation excluded here are to be considered administrative costs covered by the Contractor's fee.
 2. The cost of purchasing, renting, or furnishing small tools and hand tools.
 3. Expenses of Contractor's principal and branch offices other than Contractor's office at the Site.
 4. Any part of Contractor's capital expenses, including interest on Contractor's capital employed for the Work and charges against Contractor for delinquent payments.
 5. Costs due to the negligence of Contractor, any Subcontractor, or anyone directly or indirectly employed by any of them or for whose acts any of them may be liable, including but not limited to, the correction of defective Work, disposal of materials or equipment wrongly supplied, and making good any damage to property.
 6. Expenses incurred in preparing and advancing Claims.
 7. Other overhead or general expense costs of any kind and the costs of any item not specifically and expressly included in Paragraph 13.01.B.

D. *Contractor's Fee*

1. ~~When the Work as a whole is performed on the basis of cost plus a fee, then:
 - a. ~~Contractor's fee for the Work set forth in the Contract Documents as of the Effective Date of the Contract will be determined as set forth in the Agreement.~~
 - b. ~~for any Work covered by a Change Order, Change Proposal, Claim, set-off, or other adjustment in Contract Price on the basis of Cost of the Work, Contractor's fee will be determined as follows:
 - 8) 1) ~~When the fee for the Work as a whole is a percentage of the Cost of the Work, the fee will automatically adjust as the Cost of the Work changes.~~
 - 9) 2) ~~When the fee for the Work as a whole is a fixed fee, the fee for any additions or deletions will be determined in accordance with Paragraph 11.07.C.2.~~~~~~
2. When the Work as a whole is performed on the basis of a stipulated sum, or any other basis other than cost-plus-a-fee, then Contractor's fee for any Work covered by a Change Order, Change Proposal, Claim, set-off, or other adjustment in Contract Price on the basis of Cost of the Work will be determined in accordance with Paragraph 11.07.C.2.

- E. *Documentation and Audit*: Whenever the Cost of the Work for any purpose is to be determined pursuant to this Article 13, Contractor and pertinent Subcontractors will establish and maintain records of the costs in accordance with generally accepted accounting practices. Subject to prior written notice, Owner will be afforded reasonable access, during normal business hours, to all Contractor's accounts, records, books, correspondence, instructions, drawings, receipts, vouchers, memoranda, and similar data relating to the Cost of the Work and Contractor's fee. All such documentation may be considered public records under Florida Law as set forth in the Contract Documents and shall be maintained in accordance with Florida Law. ~~Contractor shall preserve all such documents for a period of three years after the final payment by Owner.~~ Pertinent Subcontractors will afford such access to Owner, and preserve such documents, to the same extent required of Contractor.

13.02 Allowances

- A. It is understood that Contractor has included in the Contract Price all allowances so named in the Contract Documents and shall cause the Work so covered to be performed for such sums and by such persons or entities as may be acceptable to Owner and Engineer.
- B. *Cash Allowances*: Contractor agrees that:
 1. the cash allowances include the cost to Contractor (less any applicable trade discounts) of materials and equipment required by the allowances to be delivered at the Site, and all applicable taxes; and
 2. Contractor's costs for unloading and handling on the Site, labor, installation, overhead, profit, and other expenses contemplated for the cash allowances have been included in the Contract Price and not in the allowances, and no demand for additional payment for any of the foregoing will be valid.
- C. *Owner's Contingency Allowance*: Contractor agrees that an Owner's contingency allowance, if any, is for the sole use of Owner to cover unanticipated costs.

- D. Prior to final payment, an appropriate Change Order will be issued as recommended by Engineer to reflect actual amounts due Contractor for Work covered by allowances, and the Contract Price will be correspondingly adjusted.

13.03 Unit Price Work

- A. Where the Contract Documents provide that all or part of the Work is to be Unit Price Work, initially the Contract Price will be deemed to include for all Unit Price Work an amount equal to the sum of the unit price for each separately identified item of Unit Price Work times the estimated quantity of each item as indicated in the Agreement and/or the Contract Documents.
- B. The estimated quantities of items of Unit Price Work are not guaranteed and are solely for the purpose of comparison of Bids and determining an initial Contract Price. Payments to Contractor for Unit Price Work will be based on actual quantities.
- C. Each unit price will be deemed to include an amount considered by Contractor to be adequate to cover Contractor's overhead and profit for each separately identified item.
- D. Engineer will determine the actual quantities and classifications of Unit Price Work performed by Contractor. Engineer will review with Contractor the Engineer's preliminary determinations on such matters before rendering a written decision thereon (by recommendation of an Application for Payment or otherwise). Engineer's written decision thereon will be final and binding (except as modified by Engineer to reflect changed factual conditions or more accurate data) upon Owner and Contractor, and the final adjustment of Contract Price will be set forth in a Change Order, subject to the provisions of the following paragraph.
- E. *Adjustments in Unit Price*
 - 1. Contractor or Owner shall be entitled to an adjustment in the unit price with respect to an item of Unit Price Work if:
 - a. the quantity of the item of Unit Price Work performed by Contractor differs materially and significantly from the estimated quantity of such item indicated in the Agreement; and
 - b. Contractor's unit costs to perform the item of Unit Price Work have changed materially and significantly as a result of the quantity change.
 - 2. The adjustment in unit price will account for and be coordinated with any related changes in quantities of other items of Work, and in Contractor's costs to perform such other Work, such that the resulting overall change in Contract Price is equitable to Owner and Contractor.
 - 3. Adjusted unit prices will apply to all units of that item.

ARTICLE 14—TESTS AND INSPECTIONS; CORRECTION, REMOVAL, OR ACCEPTANCE OF DEFECTIVE WORK

14.01 Access to Work

- A. Owner, Engineer, their consultants and other representatives and personnel of Owner, independent testing laboratories, and authorities having jurisdiction have access to the Site and the Work at reasonable times for their observation, inspection, and testing. Contractor

shall provide them proper and safe conditions for such access and advise them of Contractor's safety procedures and programs so that they may comply with such procedures and programs as applicable.

14.02 Tests, Inspections, and Approvals

- A. Contractor shall give Engineer timely notice of readiness of the Work (or specific parts thereof) for all required inspections and tests, and shall cooperate with inspection and testing personnel to facilitate required inspections and tests.
- B. Owner shall retain and pay for the services of an independent inspector, testing laboratory, or other qualified individual or entity to perform all inspections and tests expressly required by the Contract Documents to be furnished and paid for by Owner, except that costs incurred in connection with tests or inspections of covered Work will be governed by the provisions of Paragraph 14.05.
- C. If Laws or Regulations of any public body having jurisdiction require any Work (or part thereof) specifically to be inspected, tested, or approved by an employee or other representative of such public body, Contractor shall assume full responsibility for arranging and obtaining such inspections, tests, or approvals, pay all costs in connection therewith, and furnish Engineer the required certificates of inspection or approval.
- D. Contractor shall be responsible for arranging, obtaining, and paying for all inspections and tests required:
 - 1. by the Contract Documents, unless the Contract Documents expressly allocate responsibility for a specific inspection or test to Owner;
 - 2. to attain Owner's and Engineer's acceptance of materials or equipment to be incorporated in the Work;
 - 3. by manufacturers of equipment furnished under the Contract Documents;
 - 4. for testing, adjusting, and balancing of mechanical, electrical, and other equipment to be incorporated into the Work; and
 - 5. for acceptance of materials, mix designs, or equipment submitted for approval prior to Contractor's purchase thereof for incorporation in the Work.

Such inspections and tests will be performed by independent inspectors, testing laboratories, or other qualified individuals or entities acceptable to Owner and Engineer.

- E. If the Contract Documents require the Work (or part thereof) to be approved by Owner, Engineer, or another designated individual or entity, then Contractor shall assume full responsibility for arranging and obtaining such approvals.
- F. If any Work (or the work of others) that is to be inspected, tested, or approved is covered by Contractor without written concurrence of Engineer, Contractor shall, if requested by Engineer, uncover such Work for observation. Such uncovering will be at Contractor's expense unless Contractor had given Engineer timely notice of Contractor's intention to cover the same and Engineer had not acted with reasonable promptness in response to such notice.

14.03 Defective Work

- A. *Contractor's Obligation:* It is Contractor's obligation to assure that the Work is not defective.

- B. *Engineer's Authority*: Engineer has the authority to determine whether Work is defective, and to reject defective Work.
- C. *Notice of Defects*: Prompt written notice of all defective Work of which Owner or Engineer has actual knowledge will be given to Contractor.
- D. *Correction, or Removal and Replacement*: Promptly after receipt of written notice of defective Work, Contractor shall correct all such defective Work, whether or not fabricated, installed, or completed, or, if Engineer has rejected the defective Work, remove it from the Project and replace it with Work that is not defective.
- E. *Preservation of Warranties*: When correcting defective Work, Contractor shall take no action that would void or otherwise impair Owner's special warranty and guarantee, if any, on said Work.
- F. *Costs and Damages*: In addition to its correction, removal, and replacement obligations with respect to defective Work, Contractor shall pay all claims, costs, losses, and damages arising out of or relating to defective Work, including but not limited to the cost of the inspection, testing, correction, removal, replacement, or reconstruction of such defective Work, fines levied against Owner by governmental authorities because the Work is defective, and the costs of repair or replacement of work of others resulting from defective Work. Prior to final payment, if Owner and Contractor are unable to agree as to the measure of such claims, costs, losses, and damages resulting from defective Work, then Owner may impose a reasonable set-off against payments due under Article 15.

14.04 Acceptance of Defective Work

- A. If, instead of requiring correction or removal and replacement of defective Work, Owner prefers to accept it, Owner may do so (subject, if such acceptance occurs prior to final payment, to Engineer's confirmation that such acceptance is in general accord with the design intent and applicable engineering principles, and will not endanger public safety). Contractor shall pay all claims, costs, losses, and damages attributable to Owner's evaluation of and determination to accept such defective Work (such costs to be approved by Engineer as to reasonableness), and for the diminished value of the Work to the extent not otherwise paid by Contractor. If any such acceptance occurs prior to final payment, the necessary revisions in the Contract Documents with respect to the Work will be incorporated in a Change Order. If the parties are unable to agree as to the decrease in the Contract Price, reflecting the diminished value of Work so accepted, then Owner may impose a reasonable set-off against payments due under Article 15. If the acceptance of defective Work occurs after final payment, Contractor shall pay an appropriate amount to Owner.

14.05 Uncovering Work

- A. Engineer and/or Construction Manager has the authority to require additional inspection or testing of the Work, whether or not the Work is fabricated, installed, or completed. Engineer shall review each such additional inspection or testing of the Work.
- B. If any Work is covered contrary to the written request of Engineer, then Contractor shall, if requested by Engineer, uncover such Work for Engineer's observation, and then replace the covering, all at Contractor's expense.
- C. If Engineer considers it necessary or advisable that covered Work be observed by Engineer or inspected or tested by others, then Contractor, at Engineer's request, shall uncover, expose,

or otherwise make available for observation, inspection, or testing as Engineer may require, that portion of the Work in question, and provide all necessary labor, material, and equipment.

1. If it is found that the uncovered Work is defective, Contractor shall be responsible for all claims, costs, losses, and damages arising out of or relating to such uncovering, exposure, observation, inspection, and testing, and of satisfactory replacement or reconstruction (including but not limited to all costs of repair or replacement of work of others); and pending Contractor's full discharge of this responsibility the Owner shall be entitled to impose a reasonable set-off against payments due under Article 15.
2. If the uncovered Work is not found to be defective, Contractor shall be allowed an increase in the Contract Price or an extension of the Contract Times, directly attributable to such uncovering, exposure, observation, inspection, testing, replacement, and reconstruction. If the parties are unable to agree as to the amount or extent thereof, then Contractor may submit a Change Proposal within 30 days of the determination that the Work is not defective.

14.06 Owner May Stop the Work

- A. If the Work is defective, or Contractor fails to supply sufficient skilled workers or suitable materials or equipment, or fails to perform the Work in such a way that the completed Work will conform to the Contract Documents, then Owner may order Contractor to stop the Work, or any portion thereof, until the cause for such order has been eliminated; however, this right of Owner to stop the Work will not give rise to any duty on the part of Owner to exercise this right for the benefit of Contractor, any Subcontractor, any Supplier, any other individual or entity, or any surety for, or employee or agent of any of them.

14.07 Owner May Correct Defective Work

- A. If Contractor fails within a reasonable time after written notice from Engineer to correct defective Work, or to remove and replace defective Work as required by Engineer, then Owner may, after 7 days' written notice to Contractor, correct or remedy any such deficiency.
- B. In exercising the rights and remedies under this Paragraph 14.07, Owner shall proceed expeditiously. In connection with such corrective or remedial action, Owner may exclude Contractor from all or part of the Site, take possession of all or part of the Work and suspend Contractor's services related thereto, and incorporate in the Work all materials and equipment stored at the Site or for which Owner has paid Contractor but which are stored elsewhere. Contractor shall allow Owner, Owner's representatives, agents and employees, Owner's other contractors, and Engineer and Engineer's consultants access to the Site to enable Owner to exercise the rights and remedies under this paragraph.
- C. All claims, costs, losses, and damages incurred or sustained by Owner in exercising the rights and remedies under this Paragraph 14.07 will be charged against Contractor as set-offs against payments due under Article 15. Such claims, costs, losses and damages will include but not be limited to all costs of repair, or replacement of work of others destroyed or damaged by correction, removal, or replacement of Contractor's defective Work.
- D. Contractor shall not be allowed an extension of the Contract Times because of any delay in the performance of the Work attributable to the exercise by Owner of Owner's rights and remedies under this Paragraph 14.07.

ARTICLE 15—PAYMENTS TO CONTRACTOR; SET-OFFS; COMPLETION; CORRECTION PERIOD

15.01 Progress Payments

- A. *Basis for Progress Payments:* The Schedule of Values established as provided in Article 2 will serve as the basis for progress payments and will be incorporated into a form of Application for Payment acceptable to Engineer. Progress payments for Unit Price Work will be based on the number of units completed during the pay period, as determined under the provisions of Paragraph 13.03. Progress payments for cost-based Work will be based on Cost of the Work completed by Contractor during the pay period.
- B. *Applications for Payments*
1. At least 20 days before the date established in the Agreement for each progress payment (but not more often than once a month), Contractor shall submit to Engineer for review an Application for Payment filled out and signed by Contractor covering the Work completed as of the date of the Application and accompanied by such supporting documentation as is required by the Contract Documents.
 2. ~~If payment is requested on the basis of materials and equipment not incorporated in the Work but delivered and suitably stored at the Site or at another location agreed to in writing, the Application for Payment must also be accompanied by: (a) a bill of sale, invoice, copies of subcontract or purchase order payments, or other documentation establishing full payment by Contractor for the materials and equipment; (b) at Owner's request, documentation warranting that Owner has received the materials and equipment free and clear of all Liens; and (c) evidence that the materials and equipment are covered by appropriate property insurance, a warehouse bond, or other arrangements to protect Owner's interest therein, all of which must be satisfactory to Owner. Progress payments are to be made only on installed material, and no payments shall be made on stored material, whether on or off site, unless prior written arrangements are made with Owner.~~
 3. Beginning with the second Application for Payment, each Application must include an affidavit of Contractor stating that all previous progress payments received by Contractor have been applied to discharge Contractor's legitimate obligations associated with prior Applications for Payment.
 4. The amount of retainage with respect to progress payments will be as stipulated in the Agreement.
- C. *Review of Applications*
1. Engineer will, within 10 days after receipt of each Application for Payment, including each resubmittal, either indicate in writing a recommendation of payment and present the Application to Owner, or return the Application to Contractor indicating in writing Engineer's reasons for refusing to recommend payment. In the latter case, Contractor may make the necessary corrections and resubmit the Application.
 2. Engineer's recommendation of any payment requested in an Application for Payment will constitute a representation by Engineer to Owner, based on Engineer's observations of the executed Work as an experienced and qualified design professional, and on Engineer's

review of the Application for Payment and the accompanying data and schedules, that to the best of Engineer's knowledge, information and belief:

- a. the Work has progressed to the point indicated;
 - b. the quality of the Work is generally in accordance with the Contract Documents (subject to an evaluation of the Work as a functioning whole prior to or upon Substantial Completion, the results of any subsequent tests called for in the Contract Documents, a final determination of quantities and classifications for Unit Price Work under Paragraph 13.03, and any other qualifications stated in the recommendation); and
 - c. the conditions precedent to Contractor's being entitled to such payment appear to have been fulfilled in so far as it is Engineer's responsibility to observe the Work.
3. By recommending any such payment Engineer will not thereby be deemed to have represented that:
- a. inspections made to check the quality or the quantity of the Work as it has been performed have been exhaustive, extended to every aspect of the Work in progress, or involved detailed inspections of the Work beyond the responsibilities specifically assigned to Engineer in the Contract; or
 - b. there may not be other matters or issues between the parties that might entitle Contractor to be paid additionally by Owner or entitle Owner to withhold payment to Contractor.
4. Neither Engineer's review of Contractor's Work for the purposes of recommending payments nor Engineer's recommendation of any payment, including final payment, will impose responsibility on Engineer:
- a. to supervise, direct, or control the Work;
 - b. for the means, methods, techniques, sequences, or procedures of construction, or the safety precautions and programs incident thereto;
 - c. for Contractor's failure to comply with Laws and Regulations applicable to Contractor's performance of the Work;
 - d. to make any examination to ascertain how or for what purposes Contractor has used the money paid by Owner; or
 - e. to determine that title to any of the Work, materials, or equipment has passed to Owner free and clear of any Liens.
5. Engineer may refuse to recommend the whole or any part of any payment if, in Engineer's opinion, it would be incorrect to make the representations to Owner stated in Paragraph 15.01.C.2.
6. Engineer will recommend reductions in payment (set-offs) necessary in Engineer's opinion to protect Owner from loss because:
- a. the Work is defective, requiring correction or replacement;
 - b. the Contract Price has been reduced by Change Orders;

- c. Owner has been required to correct defective Work in accordance with Paragraph 14.07, or has accepted defective Work pursuant to Paragraph 14.04;
- d. Owner has been required to remove or remediate a Hazardous Environmental Condition for which Contractor is responsible; or
- e. Engineer has actual knowledge of the occurrence of any of the events that would constitute a default by Contractor and therefore justify termination for cause under the Contract Documents.

D. Payment Becomes Due

- 1. ~~Ten days after presentation of the Application for Payment to Owner with Engineer's recommendation, the amount recommended (subject to any Owner set-offs) will become due, and when due will be paid by Owner to Contractor. Owner shall make payment to the Contractor in the amount recommended by Engineer (subject to the provisions of this Contract) in accordance with the prompt payment provisions contained in Sections 218.70 et seq., Florida Statutes. Contractor shall make payments due to subcontractors and suppliers within ten (10) days in accordance with the prompt payment provisions contained in Section 218.735(6), 218.735(7), and 218.74, Florida Statutes.~~

E. Reductions in Payment by Owner

- 1. In addition to any reductions in payment (set-offs) recommended by Engineer, Owner is entitled to impose a set-off against payment based on any of the following:
 - a. Claims have been made against Owner based on Contractor's conduct in the performance or furnishing of the Work, or Owner has incurred costs, losses, or damages resulting from Contractor's conduct in the performance or furnishing of the Work, including but not limited to claims, costs, losses, or damages from workplace injuries, adjacent property damage, non-compliance with Laws and Regulations, and patent infringement;
 - b. Contractor has failed to take reasonable and customary measures to avoid damage, delay, disruption, and interference with other work at or adjacent to the Site;
 - c. Contractor has failed to provide and maintain required bonds or insurance;
 - d. Owner has been required to remove or remediate a Hazardous Environmental Condition for which Contractor is responsible;
 - e. Owner has incurred extra charges or engineering costs related to submittal reviews, evaluations of proposed substitutes, tests and inspections, or return visits to manufacturing or assembly facilities;
 - f. The Work is defective, requiring correction or replacement;
 - g. Owner has been required to correct defective Work in accordance with Paragraph 14.07, or has accepted defective Work pursuant to Paragraph 14.04;
 - h. The Contract Price has been reduced by Change Orders;
 - i. An event has occurred that would constitute a default by Contractor and therefore justify a termination for cause;

- j. Liquidated or other damages have accrued as a result of Contractor's failure to achieve Milestones, Substantial Completion, or final completion of the Work;
 - k. Liens have been filed in connection with the Work, except where Contractor has delivered a specific bond satisfactory to Owner to secure the satisfaction and discharge of such Liens; or
 - l. Other items entitle Owner to a set-off against the amount recommended.
- 2. If Owner imposes any set-off against payment, whether based on its own knowledge or on the written recommendations of Engineer, Owner will give Contractor immediate written notice (with a copy to Engineer) stating the reasons for such action and the specific amount of the reduction, and promptly pay Contractor any amount remaining after deduction of the amount so withheld. Owner shall promptly pay Contractor the amount so withheld, or any adjustment thereto agreed to by Owner and Contractor, if Contractor remedies the reasons for such action. The reduction imposed will be binding on Contractor unless it duly submits a Change Proposal contesting the reduction.
 - 3. Upon a subsequent determination that Owner's refusal of payment was not justified, the amount wrongfully withheld will be treated as an amount due as determined by Paragraph 15.01.D.1 and subject to interest as provided in the Agreement.

15.02 Contractor's Warranty of Title

- A. Contractor warrants and guarantees that title to all Work, materials, and equipment furnished under the Contract will pass to Owner free and clear of (1) all Liens and other title defects, and (2) all patent, licensing, copyright, or royalty obligations, no later than 7 days after the time of payment by Owner.

15.03 Substantial Completion

- A. When Contractor considers the entire Work ready for its intended use Contractor shall notify Owner and Engineer in writing that the entire Work is substantially complete and request that Engineer issue a certificate of Substantial Completion. Contractor shall at the same time submit to Owner and Engineer an initial draft of punch list items to be completed or corrected before final payment, including an estimated cost to complete each item on such punch list.
- B. Promptly after Contractor's notification, Owner, Contractor, and Engineer shall make an inspection of the Work to determine the status of completion. If Engineer does not consider the Work substantially complete, Engineer will notify Contractor in writing giving the reasons therefor.
- C. If Engineer considers the Work substantially complete, Engineer will deliver to Owner a preliminary certificate of Substantial Completion which will fix the date of Substantial Completion. Engineer shall attach to the certificate a punch list of items to be completed or corrected before final payment, including an estimated cost to complete each item on such punch list. Owner shall have 7 days after receipt of the preliminary certificate during which to make written objection to Engineer as to any provisions of the certificate or attached punch list. If, after considering the objections to the provisions of the preliminary certificate, Engineer concludes that the Work is not substantially complete, Engineer will, within 14 days after submission of the preliminary certificate to Owner, notify Contractor in writing that the Work is not substantially complete, stating the reasons therefor. If Owner does not object to the provisions of the certificate, or if despite consideration of Owner's objections Engineer

concludes that the Work is substantially complete, then Engineer will, within said 14 days, execute and deliver to Owner and Contractor a final certificate of Substantial Completion (with a revised punch list of items to be completed or corrected) reflecting such changes from the preliminary certificate as Engineer believes justified after consideration of any objections from Owner.

- D. At the time of receipt of the preliminary certificate of Substantial Completion, Owner and Contractor will confer regarding Owner's use or occupancy of the Work following Substantial Completion, review the builder's risk insurance policy with respect to the end of the builder's risk coverage, and confirm the transition to coverage of the Work under a permanent property insurance policy held by Owner. Unless Owner and Contractor agree otherwise in writing, Owner shall bear responsibility for security, operation, protection of the Work, property insurance, maintenance, heat, and utilities upon Owner's use or occupancy of the Work.
- E. After Substantial Completion the Contractor shall promptly begin work on the punch list of items to be completed or corrected prior to final payment. In appropriate cases Contractor may submit monthly Applications for Payment for completed punch list items, following the progress payment procedures set forth above.
- F. Owner shall have the right to exclude Contractor from the Site after the date of Substantial Completion subject to allowing Contractor reasonable access to remove its property and complete or correct items on the punch list.
- G. To the extent this paragraph 15.03 is inconsistent in any way with Florida's Local Government Prompt Payment Act, sections 218.70 et seq., Florida Statutes, such Act shall control, and this Contract shall be construed to allow for the maximum amount of time allowable under the Act in order to review any punch lists and make payment.

15.04 Partial Use or Occupancy

- A. Prior to Substantial Completion of all the Work, Owner may use or occupy any substantially completed part of the Work which has specifically been identified in the Contract Documents, or which Owner, Engineer, and Contractor agree constitutes a separately functioning and usable part of the Work that can be used by Owner for its intended purpose without significant interference with Contractor's performance of the remainder of the Work, subject to the following conditions:
 - 1. At any time, Owner may request in writing that Contractor permit Owner to use or occupy any such part of the Work that Owner believes to be substantially complete. If and when Contractor agrees that such part of the Work is substantially complete, Contractor, Owner, and Engineer will follow the procedures of Paragraph 15.03.A through 15.03.E for that part of the Work.
 - 2. At any time, Contractor may notify Owner and Engineer in writing that Contractor considers any such part of the Work substantially complete and request Engineer to issue a certificate of Substantial Completion for that part of the Work.
 - 3. Within a reasonable time after either such request, Owner, Contractor, and Engineer shall make an inspection of that part of the Work to determine its status of completion. If Engineer does not consider that part of the Work to be substantially complete, Engineer will notify Owner and Contractor in writing giving the reasons therefor. If Engineer considers that part of the Work to be substantially complete, the provisions of

Paragraph 15.03 will apply with respect to certification of Substantial Completion of that part of the Work and the division of responsibility in respect thereof and access thereto.

4. No use or occupancy or separate operation of part of the Work may occur prior to compliance with the requirements of Paragraph 6.04 regarding builder's risk or other property insurance.

15.05 Final Inspection

- A. Upon written notice from Contractor that the entire Work or an agreed portion thereof is complete, Engineer will promptly make a final inspection with Owner and Contractor and will notify Contractor in writing of all particulars in which this inspection reveals that the Work, or agreed portion thereof, is incomplete or defective. Contractor shall immediately take such measures as are necessary to complete such Work or remedy such deficiencies.

15.06 Final Payment

A. *Application for Payment*

1. After Contractor has, in the opinion of Engineer, satisfactorily completed all corrections identified during the final inspection and has delivered, in accordance with the Contract Documents, all maintenance and operating instructions, schedules, guarantees, bonds, certificates or other evidence of insurance, certificates of inspection, annotated record documents (as provided in Paragraph 7.12), and other documents, Contractor may make application for final payment.
 2. The final Application for Payment must be accompanied (except as previously delivered) by:
 - a. all documentation called for in the Contract Documents;
 - b. consent of the surety, if any, to final payment;
 - c. satisfactory evidence that all title issues have been resolved such that title to all Work, materials, and equipment has passed to Owner free and clear of any Liens or other title defects, or will so pass upon final payment.
 - d. a list of all duly pending Change Proposals and Claims; and
 - e. complete and legally effective releases or waivers (satisfactory to Owner) of all Lien rights arising out of the Work, and of Liens filed in connection with the Work.
 3. In lieu of the releases or waivers of Liens specified in Paragraph 15.06.A.2 and as approved by Owner, Contractor may furnish receipts or releases in full and an affidavit of Contractor that: (a) the releases and receipts include all labor, services, material, and equipment for which a Lien could be filed; and (b) all payrolls, material and equipment bills, and other indebtedness connected with the Work for which Owner might in any way be responsible, or which might in any way result in liens or other burdens on Owner's property, have been paid or otherwise satisfied. If any Subcontractor or Supplier fails to furnish such a release or receipt in full, Contractor may furnish a bond or other collateral satisfactory to Owner to indemnify Owner against any Lien, or Owner at its option may issue joint checks payable to Contractor and specified Subcontractors and Suppliers.
- B. *Engineer's Review of Final Application and Recommendation of Payment:* If, on the basis of Engineer's observation of the Work during construction and final inspection, and Engineer's

review of the final Application for Payment and accompanying documentation as required by the Contract Documents, Engineer is satisfied that the Work has been completed and Contractor's other obligations under the Contract have been fulfilled, Engineer will, within 10 days after receipt of the final Application for Payment, indicate in writing Engineer's recommendation of final payment and present the final Application for Payment to Owner for payment. Such recommendation will account for any set-offs against payment that are necessary in Engineer's opinion to protect Owner from loss for the reasons stated above with respect to progress payments. Otherwise, Engineer will return the Application for Payment to Contractor, indicating in writing the reasons for refusing to recommend final payment, in which case Contractor shall make the necessary corrections and resubmit the Application for Payment.

- C. *Notice of Acceptability*: In support of its recommendation of payment of the final Application for Payment, Engineer will also give written notice to Owner and Contractor that the Work is acceptable, subject to stated limitations in the notice and to the provisions of Paragraph 15.07.
- D. *Completion of Work*: The Work is complete (subject to surviving obligations) when it is ready for final payment as established by the Engineer's written recommendation of final payment and issuance of notice of the acceptability of the Work. Without intending to limit any other requirements set forth herein for final payment, the Work shall not be deemed complete until the Engineer has certified that, among any other requirements herein, the Contractor has completed all of the Work; there is satisfactory operation of all equipment, by means of acceptance tests; all punch list items has been corrected to the satisfaction of Owner and Engineer; the Contractor has provided all evidence of all releases of all mechanics', materialmen's and like liens; all warranties, equipment operation and maintenance manuals, As-Built Drawings and other required documents have been delivered; all other required approvals and acceptances by city, county and state governments, or other authority having jurisdiction have been provided; all rubbish, tools, and surplus materials and equipment from the Project Site have been removed; and a final affidavit and release of claims has been provided.
- E. *Final Payment Becomes Due*: Upon receipt from Engineer of the final Application for Payment and accompanying documentation, Owner shall set off against the amount recommended by Engineer for final payment any further sum to which Owner is entitled, including but not limited to set-offs for liquidated damages and set-offs allowed under the provisions of this Contract with respect to progress payments. Owner shall pay the resulting balance due to Contractor within 30 days of Owner's receipt of the final Application for Payment from Engineer.

15.07 Waiver of Claims

- A. The making of final payment will not constitute a waiver by Owner of claims or rights against Contractor. Owner expressly reserves claims and rights arising from unsettled Liens, from defective Work appearing after final inspection pursuant to Paragraph 15.05, from Contractor's failure to comply with the Contract Documents or the terms of any special guarantees specified therein, from outstanding Claims by Owner, or from Contractor's continuing obligations under the Contract Documents. By making final payment, Owner waives its claim or right to liquidated damages or other damages for late completion by Contractor, except as set forth in an outstanding Claim, appeal under the provisions of

~~Article 17, set off, or express reservation of rights by Owner. Owner reserves all other claims or rights after final payment.~~

- B. The acceptance of final payment by Contractor will constitute a waiver by Contractor of all claims and rights against Owner other than those pending matters that have been duly submitted as a Claim, or appealed under the provisions of Article 17.

15.08 Correction Period

- A. If within ~~one year~~ two years after the date of Substantial Completion (or such longer period of time as may be prescribed by the Supplementary Conditions or the terms of any applicable special guarantee required by the Contract Documents), Owner gives Contractor written notice that any Work has been found to be defective, or that Contractor's repair of any damages to the Site or adjacent areas has been found to be defective, then after receipt of such notice of defect Contractor shall promptly, without cost to Owner and in accordance with Owner's written instructions:
 - 1. correct the defective repairs to the Site or such adjacent areas;
 - 2. correct such defective Work;
 - 3. remove the defective Work from the Project and replace it with Work that is not defective, if the defective Work has been rejected by Owner, and
 - 4. satisfactorily correct or repair or remove and replace any damage to other Work, to the work of others, or to other land or areas resulting from the corrective measures.
- B. Owner shall give any such notice of defect within 60 days of the discovery that such Work or repairs is defective. If such notice is given within such 60 days but after the end of the correction period, the notice will be deemed a notice of defective Work under Paragraph 7.17.B.
- C. If, after receipt of a notice of defect within 60 days and within the correction period, Contractor does not promptly comply with the terms of Owner's written instructions, or in an emergency where delay would cause serious risk of loss or damage, Owner may have the defective Work corrected or repaired or may have the rejected Work removed and replaced. Contractor shall pay all costs, losses, and damages (including but not limited to all fees and charges of engineers, architects, attorneys, and other professionals and all court or arbitration or other dispute resolution costs) arising out of or relating to such correction or repair or such removal and replacement (including but not limited to all costs of repair or replacement of work of others). Contractor's failure to pay such costs, losses, and damages within 10 days of invoice from Owner will be deemed the start of an event giving rise to a Claim under Paragraph 12.01.B, such that any related Claim must be brought within 30 days of the failure to pay.
- D. In special circumstances where a particular item of equipment is placed in continuous service before Substantial Completion of all the Work, the correction period for that item may start to run from an earlier date if so provided in the Specifications.
- E. Where defective Work (and damage to other Work resulting therefrom) has been corrected or removed and replaced under this paragraph, the correction period hereunder with respect to such Work will be extended for an additional period of one year after such correction or removal and replacement has been satisfactorily completed.

- F. Contractor's obligations under this paragraph are in addition to all other obligations and warranties. The provisions of this paragraph are not to be construed as a substitute for, or a waiver of, the provisions of any applicable statute of limitation or repose.

ARTICLE 16—SUSPENSION OF WORK AND TERMINATION

16.01 Owner May Suspend Work

- A. At any time and without cause, Owner may suspend the Work or any portion thereof for a period of not more than 90 consecutive days by written notice to Contractor and Engineer. Such notice will fix the date on which Work will be resumed. Contractor shall resume the Work on the date so fixed. Contractor shall be entitled to an adjustment in the Contract Price or an extension of the Contract Times directly attributable to any such suspension. Any Change Proposal seeking such adjustments must be submitted no later than 30 days after the date fixed for resumption of Work.
- B. When all or a portion of the Work is suspended for any reason, Contractor shall securely fasten down all coverings and other protections necessary to protect the Work and the Site from injury by the elements or otherwise.

16.02 Owner May Terminate for Cause

- A. The occurrence of any one or more of the following events will constitute a default by Contractor and justify termination for cause:
 - 1. Contractor's persistent failure to perform the Work in accordance with the Contract Documents (including, but not limited to, failure to supply sufficient skilled workers or suitable materials or equipment, or failure to adhere to the Progress Schedule);
 - 2. Failure of Contractor to perform or otherwise to comply with a any material term of the Contract Documents;
 - 3. Contractor's disregard of Laws or Regulations of any public body having jurisdiction; or
 - 4. Contractor's repeated disregard of the authority of Owner or Engineer.
- B. If one or more of the events identified in Paragraph 16.02.A occurs, then after giving Contractor (and any surety) 10 days' written notice that Owner is considering a declaration that Contractor is in default and termination of the Contract, Owner may proceed to:
 - 1. declare Contractor to be in default, and give Contractor (and any surety) written notice that the Contract is terminated; and
 - 2. enforce the rights available to Owner under any applicable performance bond.
- C. Subject to the terms and operation of any applicable performance bond, if Owner has terminated the Contract for cause, Owner may exclude Contractor from the Site, take possession of the Work, incorporate in the Work all materials and equipment stored at the Site or for which Owner has paid Contractor but which are stored elsewhere, and complete the Work as Owner may deem expedient.
- D. Owner may not proceed with termination of the Contract under Paragraph 16.02.B if Contractor within 7 days of receipt of notice of intent to terminate begins to correct its failure to perform and proceeds diligently to cure such failure.

- E. If Owner proceeds as provided in Paragraph 16.02.B, Contractor shall not be entitled to receive any further payment until the Work is completed. If the unpaid balance of the Contract Price exceeds the cost to complete the Work, including all related claims, costs, losses, and damages (including but not limited to all fees and charges of engineers, architects, attorneys, and other professionals) sustained by Owner, such excess will be paid to Contractor. If the cost to complete the Work including such related claims, costs, losses, and damages exceeds such unpaid balance, Contractor shall pay the difference to Owner. Such claims, costs, losses, and damages incurred by Owner will be reviewed by Engineer as to their reasonableness and, when so approved by Engineer, incorporated in a Change Order. When exercising any rights or remedies under this paragraph, Owner shall not be required to obtain the lowest price for the Work performed.
- F. Where Contractor's services have been so terminated by Owner, the termination will not affect any rights or remedies of Owner against Contractor then existing or which may thereafter accrue, or any rights or remedies of Owner against Contractor or any surety under any payment bond or performance bond. Any retention or payment of money due Contractor by Owner will not release Contractor from liability.
- G. If and to the extent that Contractor has provided a performance bond under the provisions of Paragraph 6.01.A, the provisions of that bond will govern over any inconsistent provisions of Paragraphs 16.02.B and 16.02.D.

16.03 Owner May Terminate for Convenience

- A. Upon 7 days' written notice to Contractor and Engineer, Owner may, without cause and without prejudice to any other right or remedy of Owner, terminate the Contract. In such case, Owner will pay to Contractor all amounts due and not previously paid to Contractor for Work completed in accordance with the Contract prior to such notice, as well as the cost of reasonably protecting Work in place, and for Work thereafter completed as specified in such notice, as well as release and payment to Contractor of all retainage held by Owner related to the portion of the Work completed. No payments will be made for any potential costs of settling or paying claims arising out of termination of the Work under subcontracts, equipment leases, orders or other related arrangements. ~~In such case, Contractor shall be paid for (without duplication of any items):~~
 - ~~1. completed and acceptable Work executed in accordance with the Contract Documents prior to the effective date of termination, including fair and reasonable sums for overhead and profit on such Work;~~
 - ~~2. expenses sustained prior to the effective date of termination in performing services and furnishing labor, materials, or equipment as required by the Contract Documents in connection with uncompleted Work, plus fair and reasonable sums for overhead and profit on such expenses; and~~
 - ~~3. other reasonable expenses directly attributable to termination, including costs incurred to prepare a termination for convenience cost proposal.~~
- B. Contractor shall not be paid for any loss of anticipated profits or revenue, post-termination overhead costs, consequential damages of any kind, or other economic loss arising out of or resulting from such termination.
- C. Upon any such termination, Contractor shall:

1. Immediately discontinue Work on the date and to the extent specified in the notice except to the extent necessary to protect Work in place;
2. Place no further orders for materials, services, or facilities, other than as may be necessary or required for completion of such portion of Work under the Contract that is not terminated;
3. Promptly make every reasonable effort to obtain cancellation upon terms reasonably satisfactory to District of all purchase orders and Subcontracts to the extent they relate to the performance of Work terminated or assign to District those orders and Subcontracts and revoke agreements specified in such notice;
4. Reasonably assist District, as specifically requested in writing, in the maintenance, protection and disposition of property acquired by District under the Contract, as may be necessary;
5. Complete performance of any Work which is not terminated; and
6. Deliver to District an affidavit regarding the identity of unpaid potential lienors and the amounts due to each.

16.04 Contractor May Stop Work or Terminate

- A. If, through no act or fault of Contractor, (1) the Work is suspended for more than 90 consecutive days by Owner or under an order of court or other public authority, or (2) Engineer fails to act on any Application for Payment within 30 days after it is submitted, or (3) Owner fails for 30 days to pay Contractor any sum finally determined to be due, then Contractor may, upon 7 days' written notice to Owner and Engineer, and provided Owner or Engineer do not remedy such suspension or failure within that time, terminate the ~~contract~~Contract and recover from Owner payment on the same terms as provided in Paragraph 16.03.
- B. In lieu of terminating the Contract and without prejudice to any other right or remedy, if Engineer has failed to act on an Application for Payment within 30 days after it is submitted, or Owner has failed for 30 days to pay Contractor any sum finally determined to be due, Contractor may, 7 days after written notice to Owner and Engineer, stop the Work until payment is made of all such amounts due Contractor, including interest thereon. The provisions of this paragraph are not intended to preclude Contractor from submitting a Change Proposal for an adjustment in Contract Price or Contract Times or otherwise for expenses or damage directly attributable to Contractor's stopping the Work as permitted by this paragraph.

ARTICLE 17—FINAL RESOLUTION OF DISPUTES

17.01 Methods and Procedures

- A. *Disputes Subject to Final Resolution:* The following disputed matters are subject to final resolution under the provisions of this article:
 1. A timely appeal of an approval in part and denial in part of a Claim, or of a denial in full, pursuant to Article 12; and
 2. Disputes between Owner and Contractor concerning the Work, or obligations under the Contract Documents, that arise after final payment has been made.

- B. *Final Resolution of Disputes*: For any dispute subject to resolution under this article, Owner or Contractor may:
1. elect in writing to invoke the dispute resolution process provided for in the Supplementary Conditions;
 2. agree with the other party to submit the dispute to another dispute resolution process; or
 3. if no dispute resolution process is provided for in the Supplementary Conditions or mutually agreed to, give written notice to the other party of the intent to submit the dispute to a court of competent jurisdiction.
- C. In the event Owner or Contractor is required to enforce this Contract by court proceedings, alternative dispute resolution, appellate proceedings or otherwise, then the exclusive venue for any such legal action shall be in a court of appropriate jurisdiction in [] County, Florida, and the prevailing party shall be entitled to recover from the other party all fees and costs, including reasonable attorney's fees and costs, paralegal fees, and expert witness fees, incurred in bringing or defending such action and/or enforcing any judgment granted in such action.

ARTICLE 18—MISCELLANEOUS

18.01 Giving Notice

- A. Whenever any provision of the Contract requires the giving of written notice to Owner, Engineer, or Contractor, it will be deemed to have been validly given only if delivered:
1. in person, by a commercial courier service or otherwise, to the recipient's place of business;
 2. by registered or certified mail, postage prepaid, to the recipient's place of business; or
 3. by e-mail to the recipient, with the words "Formal Notice" or similar in the e-mail's subject line.

18.02 Computation of Times

- A. When any period of time is referred to in the Contract by days, it will be computed ~~to~~ based on calendar days and shall exclude the first and include the last day of such period. If the last day of any such period falls on a Saturday or Sunday or on a day made a legal holiday by the law of the applicable jurisdiction, such day will be omitted from the computation.

18.03 Cumulative Remedies

- A. The duties and obligations imposed by these General Conditions and the rights and remedies available hereunder to the parties hereto are in addition to, and are not to be construed in any way as a limitation of, any rights and remedies available to any or all of them which are otherwise imposed or available by Laws or Regulations, by special warranty or guarantee, or by other provisions of the Contract. The provisions of this paragraph will be as effective as if repeated specifically in the Contract Documents in connection with each particular duty, obligation, right, and remedy to which they apply.

18.04 Limitation of Damages

- A. With respect to any and all Change Proposals, Claims, disputes subject to final resolution, and other matters at issue, neither Owner nor Engineer, nor any of their officers, directors, members, partners, employees, supervisors, staff, agents, consultants, or subcontractors, shall be liable to Contractor for any claims, costs, losses, or damages sustained by Contractor on or in connection with any other project or anticipated project.

18.05 No Waiver

- A. A party's non-enforcement of any provision will not constitute a waiver of that provision, nor will it affect the enforceability of that provision or of the remainder of this Contract.

18.06 Survival of Obligations

- A. All representations, indemnifications, warranties, and guarantees made in, required by, or given in accordance with the Contract, as well as all continuing obligations indicated in the Contract, will survive final payment, completion, and acceptance of the Work or termination of the Contract or of the services of Contractor.

18.07 Controlling Law

- A. This Contract is to be governed by the law of the state in which the Project is located.

18.08 Assignment of Contract

- A. Unless expressly agreed to elsewhere in the Contract, no assignment by a party to this Contract of any rights under or interests in the Contract will be binding on the other party without the written consent of the party sought to be bound; and, specifically but without limitation, money that may become due and money that is due may not be assigned without such consent (except to the extent that the effect of this restriction may be limited by law), and unless specifically stated to the contrary in any written consent to an assignment, no assignment will release or discharge the assignor from any duty or responsibility under the Contract.

18.09 Successors and Assigns

- A. Owner and Contractor each binds itself, its successors, assigns, and legal representatives to the other party hereto, its successors, assigns, and legal representatives in respect to all covenants, agreements, and obligations contained in the Contract Documents.

18.10 Headings

- A. Article and paragraph headings are inserted for convenience only and do not constitute parts of these General Conditions.

18.11 Sovereign Immunity

- A. Contractor and Owner agree that nothing in this Contract shall be deemed as a waiver of the Owner's sovereign immunity or the Owner's limits of liability as set forth in Section 768.28, Florida Statutes, or other statute or law, and nothing in this Contract shall inure to the benefit of any third party for the purpose of allowing any claim which would otherwise be barred under such limitations of liability or by operation of law.

18.12 No Third-Party Beneficiaries

A. Except with respect to Contractor's indemnification of the Indemnitees as set forth herein, and except as otherwise specifically provided herein, this Contract is solely for the benefit of Owner and Contractor and no right or cause of action shall accrue upon or by reason, to or for the benefit of any third party not a formal party to this Contract (specifically including but not limited to any design professionals, subcontractors, or material suppliers directly engaged by Contractor). Nothing in this Contract expressed or implied is intended or shall be construed to confer upon any person or corporation other than Owner and Contractor any right, remedy, or claim under or by reason of this Contract or any of the provisions or conditions of this Contract; and all of the provisions, representations, covenants, and conditions contained in this Contract shall inure to the sole benefit of and shall be binding upon Owner and Contractor and their respective partners, representatives, successors, and assigns.

SUPPLEMENTARY CONDITIONS

LAKE FLORES, DS-3

The following supplements establish information supplementary to the *Standard General Conditions of the Construction Contract*, EJCDC Document No. C-700, 2018 Edition (the “**General Conditions**”), including establishing insurance limits and other requirements pursuant to Article 6, and identifying certain reports relating to subsurface conditions and hazardous conditions at the site pursuant to Article 5.

Other changes have been marked directly in underlined and strike-through text on the Standard Form of Agreement and the General Conditions. The terms used in these Supplementary Conditions have the meanings stated in the General Conditions. Additional terms used in these Supplementary Conditions have the meanings stated below, which are applicable to both the singular and plural thereof.

SC-5.03 SUBSURFACE AND PHYSICAL CONDITIONS

1. *Reports*. Pursuant to Paragraph 5.03.A.1. of the General Conditions, the following reports of explorations and tests of subsurface conditions at or adjacent to the Site are known to Owner and were used by Engineer in the preparation of the Contract Drawings and Specifications: No report available.

2. *Drawings*. Pursuant to Paragraph 5.03.A.2. of the General Conditions, the following drawings of physical conditions relating to existing surface or subsurface structures at or adjacent to the Site (except Underground Facilities) are known to Owner and were used by Engineer in the preparation of the Contract Drawings and Specifications:

Lake Flores DS-3

3. *Technical Data*. Pursuant to Paragraph 5.03.A.3. of the General Conditions, the following Technical Data is contained in the reports and drawings of subsurface and physical conditions:

No reports or drawings related to physical conditions and subsurface structures at the Site are known to the Owner.

SC-5.06 HAZARDOUS ENVIRONMENTAL CONDITIONS AT SITE

1. *Reports*. Pursuant to Paragraph 5.06.A.1. of the General Conditions, the following reports of Hazardous Environmental Conditions at or adjacent to the Site are known to Owner:

No reports or drawings related to Hazardous Environmental Conditions at the Site are known to Owner.

2. *Drawings*. Pursuant to Paragraph 5.06.A.2. of the General Conditions, the following drawings of Hazardous Environmental Conditions at or adjacent to the Site are known to Owner:

No reports or drawings related to Hazardous Environmental Conditions at the Site are known to Owner.

3. *Technical Data.* Pursuant to Paragraph 5.06.A.3. of the General Conditions, the following Technical Data is contained in the reports and drawings of Hazardous Environmental Conditions:

No reports or drawings related to Hazardous Environmental Conditions at the Site are known to Owner.

SC-6.01 PERFORMANCE, PAYMENT, AND OTHER BONDS

Contractor must provide the required Payment and Performance Bonds as required in the General Conditions. Pursuant to Paragraph 6.01.B. of the General Conditions, the following additional bonds are required:

N/A

SC-6.03 CONTRACTOR’S INSURANCE

Pursuant to Paragraph 6.03.A. of the General Conditions, the limits of Contractor’s required insurance shall be as follows.

1. Contractor shall provide coverage for not less than the following amounts, or greater where required by Laws and Regulations:

a. *Workers’ Compensation and Employer’s Liability*

Workers’ Compensation	Statutory
Employer’s Liability	
Each Accident	\$1,000,000
Each Employee	\$1,000,000
Policy Limit	\$1,000,000

b. *Commercial General Liability*

General Aggregate	\$3,000,000
Products - Completed Operations Aggregate	\$3,000,000
Personal and Advertising Injury	\$3,000,000
Bodily Injury and Property Damage*— Each Occurrence	\$3,000,000

**Property Damage liability shall provide explosion, collapse, and under-ground coverages where applicable.*

c. *Automobile Liability**

Bodily Injury	
Each Person	\$1,000,000
Each Accident	\$1,000,000
Property Damage	
Each Accident	\$1,000,000
[OR]	
Combined Single Limit (Bodily Injury and Property Damage)	\$2,000,000

**Automobile liability insurance shall include coverage for all owned, non-owned, and hired vehicles*

*d. Excess or Umbrella Liability**

Per Occurrence	\$3,000,000
General Aggregate	\$3,000,000

*e. Contractor's Pollution Liability**

Each Occurrence/Claim	\$1,000,000
General Aggregate	\$2,000,000

**Pollution liability shall cover third-party injury and property damage claims, including clean-up costs.*

f. Builder's Risk

- i. Amount* – upon the Work on a completed value basis, in the amount of the full insurable replacement cost thereof)
- ii. Form* – must be written on a builder's risk "all risk" policy form that shall at least include insurance for physical loss or damage to the Work, temporary buildings, falsework, and materials and equipment in transit, and shall insure against at least the following perils or causes of loss: fire; lightning; windstorm; riot; civil commotion; terrorism; vehicle impact; aircraft; smoke; theft; vandalism and malicious mischief; mechanical breakdown, boiler explosion, and artificially generated electric current; earthquake; volcanic activity, and other earth movement; flood; collapse; explosion; debris removal; demolition occasioned by enforcement of Laws and Regulations; water damage (other than that caused by flood); and such other perils or causes of loss as may be specifically required by the Supplementary Conditions. If insurance against mechanical breakdown, boiler explosion, and artificially generated electric current; earthquake; volcanic activity, and other earth movement; or flood, are not commercially available under builder's risk policies, by endorsement or otherwise, such insurance may be provided through other insurance policies acceptable to Owner and Contractor.
- iii. Scope* – cover, as insured property, at least the following: (a) the Work and all materials, supplies, machinery, apparatus, equipment, fixtures, and other property of a similar nature that are to be incorporated into or used in the preparation, fabrication, construction, erection, or completion of the Work, including Owner-furnished or assigned property; (b) spare parts inventory required within the scope of the Contract; and (c) temporary works which are not intended to form part of the permanent constructed Work but which are intended to provide working access to the Site, or to the Work under construction, or which are intended to provide temporary support for the Work under construction, including scaffolding, form work, fences, shoring, falsework, and temporary structures;

cover expenses incurred in the repair or replacement of any insured property (including but not limited to fees and charges of engineers and architects);

extend to cover damage or loss to insured property while in temporary storage at the Site or in a storage location outside the Site (but not including property stored at the premises of a manufacturer or Supplier);

extend to cover damage or loss to insured property while in transit;

allow for partial occupation or use of the Work by Owner, such that those portions of the Work that are not yet occupied or used by Owner shall remain covered by the builder's risk insurance;

allow for the waiver of the insurer's subrogation rights, as set forth below;

provide primary coverage for all losses and damages caused by the perils or causes of loss covered;

not include a co-insurance clause;

include an exception for ensuing losses from physical damage or loss with respect to any defective workmanship, design, or materials exclusions;

include performance/hot testing and start-up; and

be maintained in effect, subject to the provisions herein regarding Substantial Completion and partial occupancy or use of the Work by Owner, until the Work is complete.

2. All insurance policies required to be purchased and maintained will contain a provision or endorsement that the coverage afforded will not be canceled or materially changed or renewal refused until at least 30 days after notice has been received by the purchasing policyholder. Within three days of receipt of any such notice, the purchasing policyholder shall provide a copy of the notice to each other insured and Engineer.

3. Automobile liability insurance provided by Contractor will be written on an occurrence basis and provide coverage against claims for damages because of bodily injury or death of any person or property damage arising out of the ownership, maintenance, or use of any motor vehicle.

4. Contractor's commercial general liability policy will be written on a 1996 or later ISO commercial general liability occurrence form and include the following coverages and endorsements:

- a. Products and completed operations coverage maintained for three (3) years after final payment;
- b. Blanket contractual liability coverage to the extent permitted by law;
- c. Broad form property damage coverage; and
- d. Severability of interest; underground, explosion, and collapse coverage; personal injury coverage.

5. The Contractor’s commercial general liability and automobile liability, umbrella or excess, pollution liability and builder’s risk policies will include and list Owner, Engineer, and the respective supervisors, subsidiaries, affiliates, professional staff, officers, directors, members, partners, employees, agents, consultants, and subcontractors of each as additional insureds; and the insurance afforded to these additional insureds will provide primary coverage for all claims covered thereby (including, as applicable, those arising from both ongoing and completed operations) on a non-contributory basis.

6. Additional insured endorsements will include both ongoing operations and products and completed operations coverage through ISO Endorsements CG 20 10 10 01 and CG 20 37 10 01 (together). If Contractor demonstrates to Owner that the specified ISO endorsements are not commercially available, then Contractor may satisfy this requirement by providing equivalent endorsements.

7. Contractor shall provide ISO Endorsement CG 20 32 07 04, “Additional Insured—Engineers, Architects or Surveyors Not Engaged by the Named Insured” or its equivalent for design professional additional insureds.

8. Umbrella or excess liability insurance will be written over the underlying employer’s liability, commercial general liability, and automobile liability insurance. The coverage afforded must be at least as broad as that of each and every one of the underlying policies. Contractor may meet the policy limits specified for employer’s liability, commercial general liability, and automobile liability through the primary policies alone, or through combinations of the primary insurance policy’s policy limits and partial attribution of the policy limits of an umbrella or excess liability policy that is at least as broad in coverage as that of the underlying policy.

9. The Contractor shall provide property insurance covering physical loss or damage during construction to structures, materials, fixtures, and equipment, including those materials, fixtures, or equipment in storage or transit.

10. If Contractor has failed to obtain and maintain required insurance, Owner may exclude the Contractor from the Site, impose an appropriate set-off against payment, and exercise Owner’s termination rights under Article 15. Alternatively, the Owner has the right but not the obligation to secure such required insurance in which event Contractor shall pay the cost for that required insurance and shall furnish, upon demand, all information that may be required in connection with the Owner’s obtaining the required insurance.

SC-8.02 COORDINATION

Pursuant to Paragraph 8.02 of the General Conditions, if Owner intends to contract with others for the performance of other work at or adjacent to the Site, to perform other work at or adjacent to the Site with Owner’s employees, or to arrange to have utility owners perform work at or adjacent to the Site, the following information pertains to such other work:

1. The identity of the individual or entity that will have authority and responsibility for coordination of the activities among the various contractors:

[TBD]

2. An itemization of the specific matters to be covered by such authority and responsibility:

[TBD]

3. The extent of such authority and responsibilities:

[TBD]

SC-10.03 RESIDENT PROJECT REPRESENTATIVE

Pursuant to Paragraph 10.03.A. of the General Conditions, if Engineer will furnish a Resident Project Representative to represent Engineer at the Site and assist Engineer in observing the progress and quality of the Work, that representative and its authorities and responsibilities are identified below.

N / A

Pursuant to Paragraph 10.03.B. of the General Conditions, if Owner designates an individual or entity who is not Engineer's consultant, agent, or employee to represent Owner at the Site, that representative and its responsibilities and authorities are identified below.

Bond Number Assigned by Surety:

[Bond Number]

PERFORMANCE BOND

Contractor Name: [Full formal name of Contractor] Address (<i>principal place of business</i>): [Address of Contractor's principal place of business] Telephone Number: [Telephone Number]	Surety Name: [Full formal name of Surety] Address (<i>principal place of business</i>): [Address of Surety's principal place of business] Telephone Number: [Telephone Number]
Owner Name: [Full formal name of Owner] Mailing address (<i>principal place of business</i>): [Address of Owner's principal place of business] Telephone Number: [Telephone Number]	Contract Description (<i>name and location</i>): Sandridge Phase I Project, Clay County, Florida Contract Price: [Amount from Contract] Effective Date of Contract: [Date from Contract]
Bond Bond Amount: [Amount (Contract Price)] Date of Bond: [Date] <i>(Date of Bond cannot be earlier than Effective Date of Contract)</i> Modifications to this Bond form: <input type="checkbox"/> None <input checked="" type="checkbox"/> See Paragraph 16	
Surety and Contractor, intending to be legally bound hereby, subject to the terms set forth in this Performance Bond, do each cause this Performance Bond to be duly executed by an authorized officer, agent, or representative.	
Contractor as Principal	Surety
<i>(Full formal name of Contractor)</i>	<i>(Full formal name of Surety) (corporate seal)</i>
By: _____ <i>(Signature)</i>	By: _____ <i>(Signature)(Attach Power of Attorney)</i>
Name: _____ <i>(Printed or typed)</i>	Name: _____ <i>(Printed or typed)</i>
Title: _____	Title: _____
Attest: _____ <i>(Signature)</i>	Attest: _____ <i>(Signature)</i>
Name: _____ <i>(Printed or typed)</i>	Name: _____ <i>(Printed or typed)</i>
Title: _____	Title: _____
<i>Notes: (1) Provide supplemental execution by any additional parties, such as joint venturers. (2) Any singular reference to Contractor, Surety, Owner, or other party is considered plural where applicable.</i>	

EJCDC® C-610, Performance Bond.

Copyright® 2018 National Society of Professional Engineers, American Council of Engineering Companies, and American Society of Civil Engineers. All rights reserved.

Bond Number Assigned by Surety:

[Bond Number]

1. The Contractor and Surety, jointly and severally, bind themselves, their heirs, executors, administrators, successors, and assigns to the Owner for the performance of the Construction Contract, which is incorporated herein by reference.
2. If the Contractor performs the Construction Contract, the Surety and the Contractor shall have no obligation under this Bond, except when applicable to participate in a conference as provided in Paragraph 3.
3. If there is no Owner Default under the Construction Contract, the Surety's obligation under this Bond will arise after:
 - 3.1. The Owner first provides notice to the Contractor and the Surety that the Owner is considering declaring a Contractor Default. Such notice may indicate whether the Owner is requesting a conference among the Owner, Contractor, and Surety to discuss the Contractor's performance. If the Owner does not request a conference, the Surety may, within five (5) business days after receipt of the Owner's notice, request such a conference. If the Surety timely requests a conference, the Owner shall attend. Unless the Owner agrees otherwise, any conference requested under this Paragraph 3.1 will be held within ten (10) business days of the Surety's receipt of the Owner's notice. If the Owner, the Contractor, and the Surety agree, the Contractor shall be allowed a reasonable time to perform the Construction Contract, but such an agreement does not waive the Owner's right, if any, subsequently to declare a Contractor Default;
 - 3.2. The Owner declares a Contractor Default, terminates the Construction Contract and notifies the Surety; and
 - 3.3. The Owner has agreed to pay the Balance of the Contract Price in accordance with the terms of the Construction Contract to the Surety or to a contractor selected to perform the Construction Contract.
4. Failure on the part of the Owner to comply with the notice requirement in Paragraph 3.1 does not constitute a failure to comply with a condition precedent to the Surety's obligations, or release the Surety from its obligations, except to the extent the Surety demonstrates actual prejudice.
5. When the Owner has satisfied the conditions of Paragraph 3, the Surety shall promptly and at the Surety's expense take one of the following actions:
 - 5.1. Arrange for the Contractor, with the consent of the Owner, to perform and complete the Construction Contract;
 - 5.2. Undertake to perform and complete the Construction Contract itself, through its agents or independent contractors;
 - 5.3. Obtain bids or negotiated proposals from qualified contractors acceptable to the Owner for a contract for performance and completion of the Construction Contract, arrange for a contract to be prepared for execution by the Owner and a contractor selected with the Owners concurrence, to be secured with performance and payment bonds executed by a qualified surety equivalent to the bonds issued on the Construction Contract, and pay to the Owner the amount of damages as described in Paragraph 7 in excess of the Balance of the Contract Price incurred by the Owner as a result of the Contractor Default; or
 - 5.4. Waive its right to perform and complete, arrange for completion, or obtain a new contractor, and with reasonable promptness under the circumstances:

Bond Number Assigned by Surety:

[Bond Number]

- 5.4.1 After investigation, determine the amount for which it may be liable to the Owner and, as soon as practicable after the amount is determined, make payment to the Owner; or
 - 5.4.2 Deny liability in whole or in part and notify the Owner, citing the reasons for denial.
6. If the Surety does not proceed as provided in Paragraph 5 with reasonable promptness, the Surety shall be deemed to be in default on this Bond seven days after receipt of an additional written notice from the Owner to the Surety demanding that the Surety perform its obligations under this Bond, and the Owner shall be entitled to enforce any remedy available to the Owner. If the Surety proceeds as provided in Paragraph 5.4, and the Owner refuses the payment, or the Surety has denied liability, in whole or in part, without further notice, the Owner shall be entitled to enforce any remedy available to the Owner.
 7. If the Surety elects to act under Paragraph 5.1, 5.2, or 5.3, then the responsibilities of the Surety to the Owner will not be greater than those of the Contractor under the Construction Contract, and the responsibilities of the Owner to the Surety will not be greater than those of the Owner under the Construction Contract. Subject to the commitment by the Owner to pay the Balance of the Contract Price, the Surety is obligated, without duplication for:
 - 7.1. the responsibilities of the Contractor for correction of defective work and completion of the Construction Contract;
 - 7.2. additional legal, design professional, and delay costs resulting from the Contractor's Default, and resulting from the actions or failure to act of the Surety under Paragraph 5; and
 - 7.3. liquidated damages, or if no liquidated damages are specified in the Construction Contract, actual damages caused by delayed performance or non-performance of the Contractor.
 8. If the Surety elects to act under Paragraph 5.1, 5.3, or 5.4, the Surety's liability is limited to the amount of this Bond.
 9. The Surety shall not be liable to the Owner or others for obligations of the Contractor that are unrelated to the Construction Contract, and the Balance of the Contract Price will not be reduced or set off on account of any such unrelated obligations. No right of action will accrue on this Bond to any person or entity other than the Owner or its heirs, executors, administrators, successors, and assigns.
 10. The Surety hereby waives notice of any change, including changes of time, to the Construction Contract or to related subcontracts, purchase orders, and other obligations.
 11. Any proceeding, legal or equitable, under this Bond must be instituted in any court of competent jurisdiction in the location in which the work or part of the work is located and must be instituted within two years after a declaration of Contractor Default or within two years after the Contractor ceased working or within two years after the Surety refuses or fails to perform its obligations under this Bond, whichever occurs first. If the provisions of this paragraph are void or prohibited by law, the minimum periods of limitations available to sureties as a defense in the jurisdiction of the suit will be applicable.
 12. Notice to the Surety, the Owner, or the Contractor must be mailed or delivered to the address shown on the page on which their signature appears.
 13. When this Bond has been furnished to comply with a statutory or other legal requirement in the location where the construction was to be performed, any provision in this Bond conflicting with said statutory or legal requirement will be deemed deleted therefrom and provisions conforming to such

Bond Number Assigned by Surety:

[Bond Number]

statutory or other legal requirement will be deemed incorporated herein. When so furnished, the intent is that this Bond will be construed as a statutory bond and not as a common law bond.

14. Definitions

- 14.1. *Balance of the Contract Price*—The total amount payable by the Owner to the Contractor under the Construction Contract after all proper adjustments have been made including allowance for the Contractor for any amounts received or to be received by the Owner in settlement of insurance or other claims for damages to which the Contractor is entitled, reduced by all valid and proper payments made to or on behalf of the Contractor under the Construction Contract.
 - 14.2. *Construction Contract*—The agreement between the Owner and Contractor identified on the cover page, including all Contract Documents and changes made to the agreement and the Contract Documents.
 - 14.3. *Contractor Default*—Failure of the Contractor, which has not been remedied or waived, to perform or otherwise to comply with a material term of the Construction Contract.
 - 14.4. *Owner Default*—Failure of the Owner, which has not been remedied or waived, to pay the Contractor as required under the Construction Contract or to perform and complete or comply with the other material terms of the Construction Contract.
 - 14.5. *Contract Documents*—All the documents that comprise the agreement between the Owner and Contractor.
15. If this Bond is issued for an agreement between a contractor and subcontractor, the term Contractor in this Bond will be deemed to be Subcontractor and the term Owner will be deemed to be Contractor.
16. Modifications to this Bond are as follows: **This Bond is hereby amended so that the provisions and limitations of Section 255.05, including without limitation subsection (6) and the notice and time limitation provisions in subsections (2) and (10), or Sections 713.23 and 713.245, Florida Statutes, whichever are applicable, are incorporated by reference herein.**

Bond Number Assigned by Surety:

[Bond Number]

PAYMENT BOND

Contractor Name: [Full formal name of Contractor] Address (<i>principal place of business</i>): [Address of Contractor's principal place of business] Telephone Number: [Telephone Number]	Surety Name: [Full formal name of Surety] Address (<i>principal place of business</i>): [Address of Surety's principal place of business] Telephone Number: [Telephone Number]
Owner Name: [Full formal name of Owner] Mailing address (<i>principal place of business</i>): [Address of Owner's principal place of business] Telephone Number: [Telephone Number]	Contract Description (<i>name and location</i>): [Owner's project/contract name, and location of the project, and contract number, if any] Contract Price: [Amount, from Contract] Effective Date of Contract: [Date, from Contract]
Bond Bond Amount: [Amount (Contract Price)] Date of Bond: [Date] <i>(Date of Bond cannot be earlier than Effective Date of Contract)</i> Modifications to this Bond form: <input type="checkbox"/> None <input checked="" type="checkbox"/> See Paragraph 18	
Surety and Contractor, intending to be legally bound hereby, subject to the terms set forth in this Payment Bond, do each cause this Payment Bond to be duly executed by an authorized officer, agent, or representative.	
Contractor as Principal	Surety
_____ <i>(Full formal name of Contractor)</i>	_____ <i>(Full formal name of Surety) (corporate seal)</i>
By: _____ <i>(Signature)</i>	By: _____ <i>(Signature)(Attach Power of Attorney)</i>
Name: _____ <i>(Printed or typed)</i>	Name: _____ <i>(Printed or typed)</i>
Title: _____	Title: _____
Attest: _____ <i>(Signature)</i>	Attest: _____ <i>(Signature)</i>
Name: _____ <i>(Printed or typed)</i>	Name: _____ <i>(Printed or typed)</i>
Title: _____	Title: _____
<i>Notes: (1) Provide supplemental execution by any additional parties, such as joint venturers. (2) Any singular reference to Contractor, Surety, Owner, or other party is considered plural where applicable.</i>	

Bond Number Assigned by Surety:

[Bond Number]

17. The Contractor and Surety, jointly and severally, bind themselves, their heirs, executors, administrators, successors, and assigns to the Owner to pay for labor, materials, and equipment furnished for use in the performance of the Construction Contract, which is incorporated herein by reference, subject to the following terms.
18. If the Contractor promptly makes payment of all sums due to Claimants, and defends, indemnifies, and holds harmless the Owner from claims, demands, liens, or suits by any person or entity seeking payment for labor, materials, or equipment furnished for use in the performance of the Construction Contract, then the Surety and the Contractor shall have no obligation under this Bond.
19. If there is no Owner Default under the Construction Contract, the Surety's obligation to the Owner under this Bond will arise after the Owner has promptly notified the Contractor and the Surety (at the address described in Paragraph 13) of claims, demands, liens, or suits against the Owner or the Owner's property by any person or entity seeking payment for labor, materials, or equipment furnished for use in the performance of the Construction Contract, and tendered defense of such claims, demands, liens, or suits to the Contractor and the Surety.
20. When the Owner has satisfied the conditions in Paragraph 3, the Surety shall promptly and at the Surety's expense defend, indemnify, and hold harmless the Owner against a duly tendered claim, demand, lien, or suit.
21. The Surety's obligations to a Claimant under this Bond will arise after the following:
 - 21.1. Claimants who do not have a direct contract with the Contractor
 - 121..1. have furnished a written notice of non-payment to the Contractor, stating with substantial accuracy the amount claimed and the name of the party to whom the materials were, or equipment was, furnished or supplied or for whom the labor was done or performed, within ninety (90) days after having last performed labor or last furnished materials or equipment included in the Claim; and
 - 121..2. have sent a Claim to the Surety (at the address described in Paragraph 13).
 - 21.2. Claimants who are employed by or have a direct contract with the Contractor have sent a Claim to the Surety (at the address described in Paragraph 13).
22. If a notice of non-payment required by Paragraph 5.1.1 is given by the Owner to the Contractor, that is sufficient to satisfy a Claimant's obligation to furnish a written notice of non-payment under Paragraph 5.1.1.
23. When a Claimant has satisfied the conditions of Paragraph 5.1 or 5.2, whichever is applicable, the Surety shall promptly and at the Surety's expense take the following actions:
 - 23.1. Send an answer to the Claimant, with a copy to the Owner, within sixty (60) days after receipt of the Claim, stating the amounts that are undisputed and the basis for challenging any amounts that are disputed; and
 - 23.2. Pay or arrange for payment of any undisputed amounts.
 - 23.3. The Surety's failure to discharge its obligations under Paragraph 7.1 or 7.2 will not be deemed to constitute a waiver of defenses the Surety or Contractor may have or acquire as to a Claim, except as to undisputed amounts for which the Surety and Claimant have reached agreement. If, however, the Surety fails to discharge its obligations under Paragraph 7.1 or 7.2, the Surety shall indemnify the Claimant for the reasonable attorney's fees the Claimant incurs thereafter to recover any sums found to be due and owing to the Claimant.

Bond Number Assigned by Surety:

[Bond Number]

24. The Surety's total obligation will not exceed the amount of this Bond, plus the amount of reasonable attorney's fees provided under Paragraph 7.3, and the amount of this Bond will be credited for any payments made in good faith by the Surety.
25. Amounts owed by the Owner to the Contractor under the Construction Contract will be used for the performance of the Construction Contract and to satisfy claims, if any, under any construction performance bond. By the Contractor furnishing and the Owner accepting this Bond, they agree that all funds earned by the Contractor in the performance of the Construction Contract are dedicated to satisfying obligations of the Contractor and Surety under this Bond, subject to the Owner's priority to use the funds for the completion of the work.
26. The Surety shall not be liable to the Owner, Claimants, or others for obligations of the Contractor that are unrelated to the Construction Contract. The Owner shall not be liable for the payment of any costs or expenses of any Claimant under this Bond, and shall have under this Bond no obligation to make payments to or give notice on behalf of Claimants, or otherwise have any obligations to Claimants under this Bond.
27. The Surety hereby waives notice of any change, including changes of time, to the Construction Contract or to related subcontracts, purchase orders, and other obligations.
28. No suit or action will be commenced by a Claimant under this Bond other than in a court of competent jurisdiction in the state in which the project that is the subject of the Construction Contract is located or after the expiration of one year from the date (1) on which the Claimant sent a Claim to the Surety pursuant to Paragraph 5.1.2 or 5.2, or (2) on which the last labor or service was performed by anyone or the last materials or equipment were furnished by anyone under the Construction Contract, whichever of (1) or (2) first occurs. If the provisions of this paragraph are void or prohibited by law, the minimum period of limitation available to sureties as a defense in the jurisdiction of the suit will be applicable.
29. Notice and Claims to the Surety, the Owner, or the Contractor must be mailed or delivered to the address shown on the page on which their signature appears. Actual receipt of notice or Claims, however accomplished, will be sufficient compliance as of the date received.
30. When this Bond has been furnished to comply with a statutory or other legal requirement in the location where the construction was to be performed, any provision in this Bond conflicting with said statutory or legal requirement will be deemed deleted here from and provisions conforming to such statutory or other legal requirement will be deemed incorporated herein. When so furnished, the intent is that this Bond will be construed as a statutory bond and not as a common law bond.
31. Upon requests by any person or entity appearing to be a potential beneficiary of this Bond, the Contractor and Owner shall promptly furnish a copy of this Bond or shall permit a copy to be made.
32. Definitions
 - 32.1. *Claim*—A written statement by the Claimant including at a minimum:
 - 132..1. The name of the Claimant;
 - 132..2. The name of the person for whom the labor was done, or materials or equipment furnished;
 - 132..3. A copy of the agreement or purchase order pursuant to which labor, materials, or equipment was furnished for use in the performance of the Construction Contract;
 - 132..4. A brief description of the labor, materials, or equipment furnished;

Bond Number Assigned by Surety:

[Bond Number]

- 132..5. The date on which the Claimant last performed labor or last furnished materials or equipment for use in the performance of the Construction Contract;
 - 132..6. The total amount earned by the Claimant for labor, materials, or equipment furnished as of the date of the Claim;
 - 132..7. The total amount of previous payments received by the Claimant; and
 - 132..8. The total amount due and unpaid to the Claimant for labor, materials, or equipment furnished as of the date of the Claim.
- 32.2. *Claimant*—An individual or entity having a direct contract with the Contractor or with a subcontractor of the Contractor to furnish labor, materials, or equipment for use in the performance of the Construction Contract. The term Claimant also includes any individual or entity that has rightfully asserted a claim under an applicable mechanic’s lien or similar statute against the real property upon which the Project is located. The intent of this Bond is to include without limitation in the terms of “labor, materials, or equipment” that part of the water, gas, power, light, heat, oil, gasoline, telephone service, or rental equipment used in the Construction Contract, architectural and engineering services required for performance of the work of the Contractor and the Contractor’s subcontractors, and all other items for which a mechanic’s lien may be asserted in the jurisdiction where the labor, materials, or equipment were furnished.
- 32.3. *Construction Contract*—The agreement between the Owner and Contractor identified on the cover page, including all Contract Documents and all changes made to the agreement and the Contract Documents.
- 32.4. *Owner Default*—Failure of the Owner, which has not been remedied or waived, to pay the Contractor as required under the Construction Contract or to perform and complete or comply with the other material terms of the Construction Contract.
- 32.5. *Contract Documents*—All the documents that comprise the agreement between the Owner and Contractor.
33. If this Bond is issued for an agreement between a contractor and subcontractor, the term Contractor in this Bond will be deemed to be Subcontractor and the term Owner will be deemed to be Contractor.
34. Modifications to this Bond are as follows: **This Bond is hereby amended so that the provisions and limitations of Section 255.05, including without limitation subsection (6) and the notice and time limitation provisions in subsections (2) and (10), or Sections 713.23 and 713.245, Florida Statutes, whichever are applicable, are incorporated by reference herein.**

SECTION III

SUMMARY OF COSTS AND SCHEDULE

SECTION IV

This page left blank intentionally

**LAKE FLORES COMMUNITY DEVELOPMENT DISTRICT
REQUEST FOR PROPOSALS FOR LAKE FLORES, OUTFALL DS-3 PROJECT
PART I. GENERAL INFORMATION – (C) EVALUATION CRITERIA**

- 1. *Personnel* (25 Points)**
(E.g., geographic locations of the firm’s headquarters or permanent office in relation to the project, capabilities and experience of key personnel, including the project manager and field supervisor; present ability to manage this project; evaluation of existing work load; proposed staffing levels, etc.)
- 2. *Proposer’s Experience* (25 Points)**
(E.g., past record and experience of the Proposer in similar projects; volume of work previously performed by the firm; past performance for other community development districts in other contracts; character, integrity, reputation of respondent, etc.)
- 3. *Understanding of Scope of Work* (10 Points)**
Extent to which the proposal demonstrates an understanding of the District’s needs for the services requested.
- 4. *Financial Capability* (10 Points)**
Extent to which the proposal demonstrates the adequacy of Proposer’s financial resources and stability as a business entity, necessary to complete the services required.
- 5. *Price* (30 Total Points)**

Points available for price will be allocated as follows:

25 Points will be awarded to the Proposer submitting the lowest total price proposal, (i.e., the summation of the unit price extensions using quantity estimates provided, the allowances shown, plus the proposal contractor’s fee) for completing the work. Value engineering concepts deemed reasonable, in the sole discretion of the district, shall also be taken into account when determining Proposer’s price proposal. All other proposals will receive a percentage of the amount based upon the difference between the Proposer’s bid and the low bid.

5 Points are allocated for the reasonableness of unit prices and balance of bid.

LAKE FLORES COMMUNITY DEVELOPMENT DISTRICT

REQUEST FOR PROPOSALS FOR OUTFALL DS-3

EVALUATION MATRIX

PROPOSER	PERSONNEL	PROPOSER'S EXPERIENCE	UNDERSTANDING SCOPE OF WORK	FINANCIAL CAPABILITY	PRICE	TOTAL POINTS
	25 POINTS	25 POINTS	10 POINTS	10 POINTS	30 POINTS	100 POINTS

NOTES

Completed by: _____

Board Member's Signature

Date: _____

Printed Name of Board Member